



Solider Schutz

Solid ist sowohl in Innenräumen als auch im Freien der großartige Alleskönner. Wenn Sie Ihre Ausrüstung ganz allgemein in Alltagsumgebungen schützen wollen, ist Solid die optimale Universallösung für Ihre elektronischen und elektrischen Komponenten.

Die ideale Alternative zu Polyestergehäusen.
Mit Schraub- oder Scharnierabdeckung, aus Polycarbonat/ABS.



Gehäuse

- 1 Unterteil
- 2 Deckel, grau oder transparent
- 3 Deckelschrauben, diverse Ausführungen

Zubehör

- 4 Befestigungslaschen 2 Stk. inkl. Schrauben
- 5 Montageplatte, Stahl, galvanisch verzinkt stabil und schlagfest
- 6 Tragschiene mit Montageschrauben
- 7 Zwischenrahmen

SOLID

Besteht aus: Unterteil inkl. Montageschrauben, Deckel inkl. PUR Dichtung und Polyamid Deckelschrauben.

PC: IP66/IP67, IK09/IK08

ABS: IP66/IP67, IK08

Abmessungen	Bestellzeichen	Artikelnummer	EAN Code	Beschreibung
188x188x130 mm				
	PC 1919 13 G	5330359	 6 418074 005403	Gehäuse PC grauer Deckel
	PC 1919 13 G-2FSH	2539505	 6 418074 052704	Gehäuse PC grauer Scharnierdeckel
	PC 1919 13 T	5330059	 6 418074 005397	Gehäuse PC transparenter Deckel
	PC 1919 13 T-2FSH	2539535	 6 418074 052827	Gehäuse PC transparenter Scharnierdeckel
	ABS 1919 13 G	5880359	 6 418074 039002	Gehäuse ABS grauer Deckel
	ABS 1919 13 G-2FSH	9880401	 6 418074 053428	Gehäuse ABS grauer Scharnierdeckel
	ABS 1919 13 T	5880059	 6 418074 039125	Gehäuse ABS transparenter Deckel
	ABS 1919 13 T-2FSH	9880451	 6 418074 053541	Gehäuse ABS transparenter Scharnierdeckel
188x188x180 mm				
	PC 1919 18 G	5330369	 6 418074 005427	Gehäuse PC grauer Deckel
	PC 1919 18 G-2FSH	2539507	 6 418074 052766	Gehäuse PC grauer Scharnierdeckel
	PC 1919 18 T	5330069	 6 418074 005410	Gehäuse PC transparenter Deckel
	PC 1919 18 T-2FSH	2539537	 6 418074 052889	Gehäuse PC transparenter Scharnierdeckel
	ABS 1919 18 G	5880369	 6 418074 039019	Gehäuse ABS grauer Deckel
	ABS 1919 18 G-2FSH	9880405	 6 418074 053480	Gehäuse ABS grauer Scharnierdeckel

Abmessungen	Bestellzeichen	Artikelnummer	EAN Code	Beschreibung
	ABS 1919 18 T	5880069	 6 418074 039132	Gehäuse ABS transparenter Deckel
	ABS 1919 18 T-2FSH	9880455	 6 418074 061003	Gehäuse ABS transparenter Scharnierdeckel
278x188x130 mm				
	PC 2819 13 G	5330360	 6 418074 005441	Gehäuse PC grauer Deckel
	PC 2819 13 G-2FSH	2539509	 6 418074 052711	Gehäuse PC grauer Scharnierdeckel
	PC 2819 13 T	5330060	 6 418074 005434	Gehäuse PC transparenter Deckel
	PC 2819 13 T-2FSH	2539539	 6 418074 052834	Gehäuse PC transparenter Scharnierdeckel
	ABS 2819 13 G	5880360	 6 418074 039026	Gehäuse ABS grauer Deckel
	ABS 2819 13 G-2FSH	9996267	 6 418074 053435	Gehäuse ABS grauer Scharnierdeckel
	ABS 2819 13 T	5880060	 6 418074 039149	Gehäuse ABS transparenter Deckel
	ABS 2819 13 T-2FSH	9880459	 6 418074 053558	Gehäuse ABS transparenter Scharnierdeckel

SOLID

Besteht aus: Unterteil inkl. Montageschrauben, Deckel inkl. PUR Dichtung und Polyamid Deckelschrauben.

PC: IP66/IP67, IK09/IK08

ABS: IP66/IP67, IK08

Abmessungen	Bestellzeichen	Artikelnummer	EAN Code	Beschreibung
278x188x180 mm				
	PC 2819 18 G	5330370	 6 418074 005465	Gehäuse PC grauer Deckel
	PC 2819 18 G-2FSH	2539511	 6 418074 052773	Gehäuse PC grauer Scharnierdeckel
	PC 2819 18 T	5330070	 6 418074 005458	Gehäuse PC transparenter Deckel
	PC 2819 18 T-2FSH	2539541	 6 418074 052896	Gehäuse PC transparenter Scharnierdeckel
	ABS 2819 18 G	5880370	 6 418074 039033	Gehäuse ABS grauer Deckel
	ABS 2819 18 G-2FSH	9996268	 6 418074 053497	Gehäuse ABS grauer Scharnierdeckel
	ABS 2819 18 T	5880070	 6 418074 039156	Gehäuse ABS transparenter Deckel
	ABS 2819 18 T-2FSH	9880463	 6 418074 061010	Gehäuse ABS transparenter Scharnierdeckel
378x188x130 mm				
	PC 3819 13 G	5330361	 6 418074 005489	Gehäuse PC grauer Deckel
	PC 3819 13 G-2FSH	2539513	 6 418074 052735	Gehäuse PC grauer Scharnierdeckel
	PC 3819 13 T	5330061	 6 418074 005472	Gehäuse PC transparenter Deckel
	PC 3819 13 T-2FSH	2539543	 6 418074 052858	Gehäuse PC transparenter Scharnierdeckel
	ABS 3819 13 G	5880361	 6 418074 039040	Gehäuse ABS grauer Deckel
	ABS 3819 13 G-2FSH	9880425	 6 418074 053442	Gehäuse ABS grauer Scharnierdeckel
	ABS 3819 13 T	5880061	 6 418074 039163	Gehäuse ABS transparenter Deckel













Abmessungen	Bestellzeichen	Artikelnummer	EAN Code	Beschreibung
	ABS 3819 13 T-2FSH	9880475	 6 418074 053565	Gehäuse ABS transparenter Scharnierdeckel
378x188x180 mm				
	PC 3819 18 G	5330371	 6 418074 005502	Gehäuse PC grauer Deckel
	PC 3819 18 G-2FSH	2539515	 6 418074 052797	Gehäuse PC grauer Scharnierdeckel
	PC 3819 18 T	5330071	 6 418074 005496	Gehäuse PC transparenter Deckel
	PC 3819 18 T-2FSH	2539545	 6 418074 052919	Gehäuse PC transparenter Scharnierdeckel
	ABS 3819 18 G	5880371	 6 418074 039057	Gehäuse ABS grauer Deckel
	ABS 3819 18 G-2FSH	9880429	 6 418074 053503	Gehäuse ABS grauer Scharnierdeckel
	ABS 3819 18 T	5880071	 6 418074 039170	Gehäuse ABS transparenter Deckel
	ABS 3819 18 T-2FSH	9880479	 6 418074 061027	Gehäuse ABS transparenter Scharnierdeckel
278x278x130 mm				
	PC 2828 13 G	5330362	 6 418074 005526	Gehäuse PC grauer Deckel
	PC 2828 13 G-2FSH	2539517	 6 418074 052728	Gehäuse PC grauer Scharnierdeckel
	PC 2828 13 T	5330062	 6 418074 005519	Gehäuse PC transparenter Deckel
	PC 2828 13 T-2FSH	2539547	 6 418074 052841	Gehäuse PC transparenter Scharnierdeckel
	ABS 2828 13 G	5880362	 6 418074 039064	Gehäuse ABS grauer Deckel
	ABS 2828 13 G-2FSH	9880417	 6 418074 053459	Gehäuse ABS grauer Scharnierdeckel

















SOLID

Besteht aus: Unterteil inkl. Montageschrauben, Deckel inkl. PUR Dichtung und Polyamid Deckelschrauben.

PC: IP66/IP67, IK09/IK08

ABS: IP66/IP67, IK08

Abmessungen	Bestellzeichen	Artikelnummer	EAN Code	Beschreibung
	ABS 2828 13 T	5880062	 6 418074 039187	Gehäuse ABS transparenter Deckel
	ABS 2828 13 T-2FSH	9880467	 6 418074 060976	Gehäuse ABS transparenter Scharnierdeckel
278x278x180 mm				
	PC 2828 18 G	5330372	 6 418074 005540	Gehäuse PC grauer Deckel
	PC 2828 18 G-2FSH	2539519	 6 418074 052780	Gehäuse PC grauer Scharnierdeckel
	PC 2828 18 T	5330072	 6 418074 005533	Gehäuse PC transparenter Deckel
	PC 2828 18 T-2FSH	2539549	 6 418074 052902	Gehäuse PC transparenter Scharnierdeckel
	ABS 2828 18 G	5880372	 6 418074 039071	Gehäuse ABS grauer Deckel
	ABS 2828 18 G-2FSH	9880421	 6 418074 053510	Gehäuse ABS grauer Scharnierdeckel
	ABS 2828 18 T	5880072	 6 418074 039194	Gehäuse ABS transparenter Deckel
	ABS 2828 18 T-2FSH	9880471	 6 418074 061034	Gehäuse ABS transparenter Scharnierdeckel
378x278x130 mm				
	PC 3828 13 G	5330363	 6 418074 005564	Gehäuse PC grauer Deckel
	PC 3828 13 G-2FSH	2539521	 6 418074 052742	Gehäuse PC grauer Scharnierdeckel
	PC 3828 13 T	5330063	 6 418074 005557	Gehäuse PC transparenter Deckel
	PC 3828 13 T-2FSH	2539551	 6 418074 052865	Gehäuse PC transparenter Scharnierdeckel
	ABS 3828 13 G	5880363	 6 418074 039088	Gehäuse ABS grauer Deckel

Abmessungen	Bestellzeichen	Artikelnummer	EAN Code	Beschreibung
	ABS 3828 13 G-2FSH	9996276	 6 418074 053466	Gehäuse ABS grauer Scharnierdeckel
	ABS 3828 13 T	5880063	 6 418074 039200	Gehäuse ABS transparenter Deckel
	ABS 3828 13 T-2FSH	9996269	 6 418074 060983	Gehäuse ABS transparenter Scharnierdeckel
378x278x180 mm				
	PC 3828 18 G	5330373	 6 418074 005588	Gehäuse PC grauer Deckel
	PC 3828 18 G-2FSH	2539523	 6 418074 052803	Gehäuse PC grauer Scharnierdeckel
	PC 3828 18 T	5330073	 6 418074 005571	Gehäuse PC transparenter Deckel
	PC 3828 18 T-2FSH	2539553	 6 418074 052926	Gehäuse PC transparenter Scharnierdeckel
	ABS 3828 18 G	5880373	 6 418074 039095	Gehäuse ABS grauer Deckel
	ABS 3828 18 G-2FSH	9996275	 6 418074 053527	Gehäuse ABS grauer Scharnierdeckel
	ABS 3828 18 T	5880073	 6 418074 039217	Gehäuse ABS transparenter Deckel
	ABS 3828 18 T-2FSH	9996270	 6 418074 061041	Gehäuse ABS transparenter Scharnierdeckel
558x278x130 mm				
	PC 5628 13 G	5330364	 6 418074 005601	Gehäuse PC grauer Deckel
	PC 5628 13 G-3FSH	2539525	 6 418074 052759	Gehäuse PC grauer Scharnierdeckel
	PC 5628 13 T	5330064	 6 418074 005595	Gehäuse PC transparenter Deckel
	PC 5628 13 T-3FSH	2539555	 6 418074 052872	Gehäuse PC transparenter Scharnierdeckel

SOLID

Besteht aus: Unterteil inkl. Montageschrauben, Deckel inkl. PUR Dichtung und Polyamid Deckelschrauben.

PC: IP66/IP67, IK09/IK08

ABS: IP66/IP67, IK08

Abmessungen	Bestellzeichen	Artikelnummer	EAN Code	Beschreibung
	ABS 5628 13 G	5880364	 6 418074 039101	Gehäuse ABS grauer Deckel
	ABS 5628 13 G-3FSH	9880441	 6 418074 053473	Gehäuse ABS grauer Scharnierdeckel
	ABS 5628 13 T	5880064	 6 418074 039224	Gehäuse ABS transparenter Deckel
	ABS 5628 13 T-3FSH	9996271	 6 418074 060990	Gehäuse ABS transparenter Scharnierdeckel
558x378x180 mm				
	PC 5638 18 G	5330365	 6 418074 005625	Gehäuse PC grauer Deckel
	PC 5638 18 G-3FSH	2539527	 6 418074 052810	Gehäuse PC grauer Scharnierdeckel
	PC 5638 18 T	5330065	 6 418074 005618	Gehäuse PC transparenter Deckel
	PC 5638 18 T-3FSH	2539557	 6 418074 052933	Gehäuse PC transparenter Scharnierdeckel
	ABS 5638 18 G	5880365	 6 418074 039118	Gehäuse ABS grauer Deckel
	ABS 5638 18 G-3FSH	9880445	 6 418074 053534	Gehäuse ABS grauer Scharnierdeckel
	ABS 5638 18 T	5880065	 6 418074 039231	Gehäuse ABS transparenter Deckel
	ABS 5638 18 T-3FSH	9996272	 6 418074 061058	Gehäuse ABS transparenter Scharnierdeckel

Besteht aus: Unterteil inkl. Montageschrauben, Deckel inkl. PUR Dichtung und Polyamid Deckelschrauben.

PC: IP66/IP67, IK09/IK08
ABS: IP66/IP67, IK08











SOLID Technische Informationen			Approbationen
Eigenschaften	Polycarbonat (PC)	ABS	
Schutzart (EN 60529)	IP 66/IP 67	IP 66/IP 67	USA Gehäuse für elektrische Ausrüstung PC: UL Type 1, 3, 3S, 4, 4X, 6, 6P oder 12; UL File E75645 Vol 1 Sec 2; UL 746C-5VA vertikaler Flammentest (UL 50/508)* ABS: NEMA 1, 3, 3S, 4, 4X, 6, 6P oder 12 Kanada Industrielle Kontrollausrüstung Gehäuse für elektrische Kontrollausrüstung/ULc* Europa Gehäuse für Schalt- und Kontrollanlagen und Kontrollanlagen Zubehör EN 62208:2003 Europa Sicherheit für Ausrüstungen in der Informationstechnologie EN 60950 RoHS Richtlinie 2002/95/EC Russland GostR - Gost Russian certificate of conformity *UL label auf Anfrage
Schlagfestigkeit (EN 62262)	IK 08 (Seitenfläche) IK 09 (Stirnfläche)	IK 08	
Temperaturbeständigkeit Celsius (Kurzzeit) Fahrenheit	-40°...120°C -40°...250°F	-40°...80°C -40°...175°F	
Temperaturbeständigkeit Celsius (Dauergebrauch) Fahrenheit	-40°...80°C -40°...175°F	-40°...60°C -40°...140°F	
Elektrische Isolation	voll isoliert ☐	voll isoliert ☐	
Farbton hellgraue Teile	RAL 7035 Lichtgrau	RAL 7035 Lichtgrau	
PC-Deckel transparent, Farbe	Klar transparent	Klar transparent	
Deckelschrauben, Farbe	RAL 7035	RAL 7035	
Deckelschrauben, Material	Polyamid (PA)	Polyamid (PA)	
Dichtung	PUR	PUR	
Brandklassifikation	UL 746C 5V*		
Glühdrahttest (IEC 695-2-1) selbstverlöschend (PC)	960°C	650°C	
Halogenfrei	ja	ja	
UV-Beständigkeit	UL 508 720 Stunden im "Witterungstest"		
Chemische Beständigkeit**	Gut	Gut	

Technische Änderungen vorbehalten

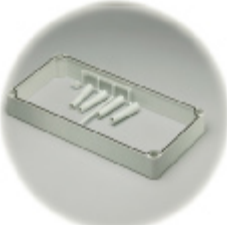
**Für weitere Informationen fordern Sie bitte das separate Datenblatt über Rohstoffe an.

	Bestell- zeichen	Artikel- nummer	Abmes- sungen	EAN Code	Beschreibung
Montageplatte (galvanisch verzinkter Stahl, 1,5 mm dick)					
	EKHVT	3770548	148x148	 6 418074 039743	Montageplatte, für Gehäuse 190x190x130, 190x190x180
	EKJVT	3770549	148x238	 6 418074 039750	Montageplatte, für Gehäuse 280x190x130, 280x190x180
	EKMVT	3770550	148x338	 6 418074 039767	Montageplatte, für Gehäuse 380x190x130, 380x190x180
	EKOVT	3770551	238x238	 6 418074 039774	Montageplatte, für Gehäuse 280x280x130, 280x280x180
	EKPVT	3770552	238x338	 6 418074 039781	Montageplatte, für Gehäuse 380x280x130, 380x280x180, 380x280x230
	EKTVT	3770553	238x518	 6 418074 039798	Montageplatte, für Gehäuse 560x280x130
	EKUVT	3770554	338x518	 6 418074 039804	Montageplatte, für Gehäuse 560x380x180
	PT 60 x 11 PH2 SET	3570580		 6 418074 031426	Montageschraubensatz (4St) für Eckbefestigungspunkte
Montageplatte Pertinax 4mm					
	EKHXT	3770748	148x148	 6 418074 029362	Montageplatte, für Gehäuse: 190x190x130, 190x190x180
	EKJXT	3770749	148x240	 6 418074 029379	Montageplatte, für Gehäuse: 280x190x130, 280x190x180
	EKMXT	3770750	148x340	 6 418074 029386	Montageplatte, für Gehäuse: 380x190x130, 380x190x180
	EKOXT	3770751	238x238	 6 418074 029393	Montageplatte, für Gehäuse: 280x280x130, 280x280x180
	EKPXT	3770752	238x338	 6 418074 029409	Montageplatte, für Gehäuse: 380x280x130, 380x280x180
	EKTXT	3770753	236x518	 6 418074 029416	Montageplatte, für Gehäuse: 560x280x130

	Bestellzeichen	Artikelnummer	Abmessungen	EAN Code	Beschreibung
	EKUXT	3770754	339x518	 6 418074 029423	Montageplatte, für Gehäuse: 560x380x180
Montageplatte für kWh-Zähler					
	EKPVM2	3770839	238x338	 6 418074 040831	338 x 238 für kWh-Zähler
	M6x16	3570678		 6 418074 031570	Schrauben zur Befestigung des kWh-Zählers
DIN-35 Montageschiene (galvanisch verzinkter Stahl, 7,5 mm hoch)					
	EKV 12	3770647	160x35	 6 418074 031969	Tragschiene TS 35, für Gehäuse 190x190x130-380x190x180
	EKV 22	3770648	235x35	 6 418074 031976	Tragschiene TS 35, für Gehäuse 280x280x130-560x280x130
	EKV 32	3770649	335x35	 6 418074 031983	Tragschiene TS 35, für Gehäuse 380x190x130, 380x190x180, 380x280x130, 380x280x180, 380x280x230, 560x380x180,
	EKV 50	3770699	500x35	 6 418074 030405	Tragschiene TS 35, für Gehäuse 560x280x130
Tragschienen Zubehör					
	MSM PT 5x10	4712049		 6 418074 032577	Montageschraube für mittige Befestigungspunkte
	PT 60 x 11 PH2 SET	3570580		 6 418074 031426	Montageschraubensatz (4St) für Eckbefestigungspunkte
	MB 10686	3730686		 6 418074 031181	2 Distanzstücke inkl. Schrauben 15/34 mm

	Bestell- zeichen	Artikel- nummer	Abmes- sungen	EAN Code	Beschreibung
Rahmen für DIN-Schienen					
	MS PROF 19	3510840		 6 418074 040480	Rahmen für DIN-Schiene
	MS PROF 28	3510841		 6 418074 040497	Rahmen für DIN-Schiene
	MS PROF 38	3510842		 6 418074 031310	Rahmen für DIN-Schiene
	MS PROF 56	3510843		 6 418074 040503	Rahmen für DIN-Schiene
	EKT PROF 56	3510844		 6 418074 031327	Rahmen für DIN-Schiene
Zwischenrahmen (Polycarbonat, PUR Dichtung)					
	EKJZR	3730153	188x278	 6 418074 005724	Zwischenrahmen (50 mm hoch), für Gehäuse 280x190x130, 280x190x180
	EKMZR	3730152	188x378	 6 418074 005731	Zwischenrahmen (50 mm hoch), für Gehäuse 380x190x130, 380x190x180
	EKOZR	3730093	278x278	 6 418074 005748	Zwischenrahmen (50 mm hoch), für Gehäuse 280x280x130, 280x280x180
	EKPZR	3730141	278x378	 6 418074 005755	Zwischenrahmen (50 mm hoch), für Gehäuse 380x280x130, 380x280x180, 380x280x230
	EKTZR	3730142	278x558	 6 418074 005762	Zwischenrahmen (50 mm hoch), für Gehäuse 560x280x130
	EKUZR	3730323	378x558	 6 418074 005779	Zwischenrahmen (50 mm hoch), für Gehäuse 560x380x180

	Bestell- zeichen	Artikel- nummer	Abmes- sungen	EAN Code	Beschreibung
Frontplatten mit DIN-Öffnungen					
	FP12-2819	3770765	190x280	 6 418074 006318	Frontplatte 12 Module
	FP12-2828	3770756	280x280	 6 418074 006325	Frontplatte 12 Module
	FP12x2-2828	3770766	280x280	 6 418074 006332	Frontplatte 2x12 Module
	FP12x2-2838	3770769	380x280	 6 418074 006349	Frontplatte 2x12 Module
	FP12x3-2838	3770767	380x280	 6 418074 006356	Frontplatte 3x12 Module
	FP12x3-2856	3770768	560x280	 6 418074 006363	Frontplatte 3x12 Module
MB FP88 und MB FP882 Distanzstücke					
	MB FP88	3530764		 6 418074 036001	Distanzstück für Frontplatten
	MB FP882	3530771		 6 418074 035868	Distanzstück für Frontplatten
	MB 26050	5026050		 6 418074 034830	Abdeckplatte für 12 Module
	MB 26069SET	5126029		 6 418074 031747	Trägersatz
	MS BAR CLAMP	4712232		 6 418074 040886	Reihenklemme auf PE/N Klemme 25 mm ²
	MR 26145	5026145		 6 418074 039903	PEN 35 mm ² Leiter- Anschlussklemme

	Bestell- zeichen	Artikel- nummer	Abmes- sungen	EAN Code	Beschreibung
Polycarbonat Frontplatten für FX20 SET					
	FX FP 8-2819	3770849	190x280	 6 418074 030108	Frontplatte, blau für 8 Module
	FX FP 12-2828	3770850	280x280	 6 418074 030115	Frontplatte, blau für 12 Module
	FX FP 2*12- 2838	3770851	280x380	 6 418074 030290	Frontplatte, blau für 2x12 Module
	FX FP 3*12- 2856	3770852	280x560	 6 418074 030313	Frontplatte, blau für 3x12 Module
Distanzstücke FX20 SET					
	FX20 SET	3570791		 6 418074 035165	Distanzstück Set (4 St.)
	MB 10791	3730791		 6 418074 010544	Distanzstück (separat)
	MB 10792	3730792		 6 418074 010551	Montageschraube für Frontplatte
	MS BAR 2+18	4712199	7x10	 6 418074 040855	PE/N Terminal Sammelschiene 25+10 mm ²
Frontplatte für MB 60MM Sammelschienen					
	MB FP 2828	3770853	280x280	 6 418074 031341	Frontplatte PC, 2 mm in blau
	MB FP 3828	3770854	280x380	 6 418074 031358	Frontplatte PC, 2 mm in blau
	MB FP 5628	3770855	280x560	 6 418074 031372	Frontplatte PC, 2 mm in blau

	Bestellzeichen	Artikelnummer	Abmessungen	EAN Code	Beschreibung
60 MM Sammelschiene					
	MB 60MM	3532385		 6 418074 031600	Befestigungsset für Sammelschiene inkl. Schrauben
	MB 10792	3730792		 6 418074 010551	Montageschraube für Frontplatte
Scharniere und Wandbefestigungen					
	MB 10622	3530622		 6 418074 039644	Scharniersatz, PC
	MB 10547	3570547		 6 418074 031280	Scharniersatz, PA
	EKZKS 1	3570570		 6 418074 009883	Scharniersatz, Stahl
	MB 10523	3560523		 6 418074 031174	Blindpfropfen
	MB 10674	3770674		 6 418074 039651	Wandbefestigungslaschen 4 St. inkl. Schrauben
Deckelschrauben					
	HS 10255	3540255		 6 418074 030672	Flügelkopfschraube für 30 mm Deckel
	CS 10256	3540256		 6 418074 030689	Kreuzkopfschraube für 30/100 mm Deckel
	SS 10535	3540535		 6 418074 030702	Schlitzkopfschraube für 30 mm Deckel
	SS 10544	3570544		 6 418074 031273	Schlitzkopfschraube (Schnellverschluss) für 30/100 mm Deckel
	HS 10533	3570533		 6 418074 031266	Flügelkopfschraube (Schnellverschluss) für 30 mm Deckel
	HS 10532	3570532		 6 418074 031259	Schnellverschluss-Flügelkopfschraube (Scharnier) für 30 mm Deckel

	Bestell- zeichen	Artikel- nummer	Abmes- sungen	EAN Code	Beschreibung
	MB 10534	3540534		 6 418074 030696	Gewindebuchse erforderlich für Schnellverschlusschrauben
	SS 10563	3540563		 6 418074 030733	Kreuzkopfschraube für 80 mm Deckel
	HS 10562	3540562		 6 418074 030726	Flügelkopfschraube für 80 mm Deckel
	DS 10581	3540581		 6 418074 030757	Dreieckkopfschraube für 30/80/100 mm Deckel
	MB 10673	3570673		 6 418074 031563	Dreieckschlüssel zu verwenden mit DS 10581
	SS 10256 N	3510256		 6 418074 030023	Dreieckkopfschraube Noryl für 30 mm Deckel
	HS 10255 N	3510255		 6 418074 030016	Flügelkopfschraube Noryl für 30 mm Deckel
	SS 10256-4	3544256		 6 418074 030856	Kreuzkopfschraube, Satz von 4 Stück für 30/100 mm Deckel
	SS 10256-6	3546256		 6 418074 030979	Kreuzkopfschraube, Satz von 6 Stück für 30/100 mm Deckel
	SS 10563-4	3544563		 6 418074 030870	Kreuzkopfschraube, Satz von 4 Stück für 80 mm Deckel
Distanzstücke für Gehäuseecken					
	MR 10726	5070726		 6 418074 032089	Distanzstück 15 mm M6 selbstschneidend
	MR 10727	5070727		 6 418074 032096	Distanzstück 20 mm M6 selbstschneidend
	MR 10728	5070728		 6 418074 032102	Distanzstück 30 mm M6 selbstschneidend
	MR 10729	5070729		 6 418074 032119	Distanzstück 54 mm M6 selbstschneidend
	HR 10	3570655		 6 418074 040596	Distanzstück mit M6 Gewinde

	Bestellzeichen	Artikelnummer	Abmessungen	EAN Code	Beschreibung
	HR 15	3570656		 6 418074 031501	Distanzstück mit M6 Gewinde
	HR 20	3570657		 6 418074 031518	Distanzstück mit M6 Gewinde
	HR 30	3570658		 6 418074 031525	Distanzstück mit M6 Gewinde
Distanzstücke für mittige Befestigungspunkte					
	FA 12053	4712053		 6 418074 032171	Distanzstück 14 mm M5 selbstschneidend
	FA 12052	4712052		 6 418074 032164	Distanzstück 42 mm M5 selbstschneidend
Schloßsatz					
	MB 10597	3570597		 6 418074 039668	Schloß-Satz mit Schloß + 2 Schlüssel

SOLID 188x188x130-180

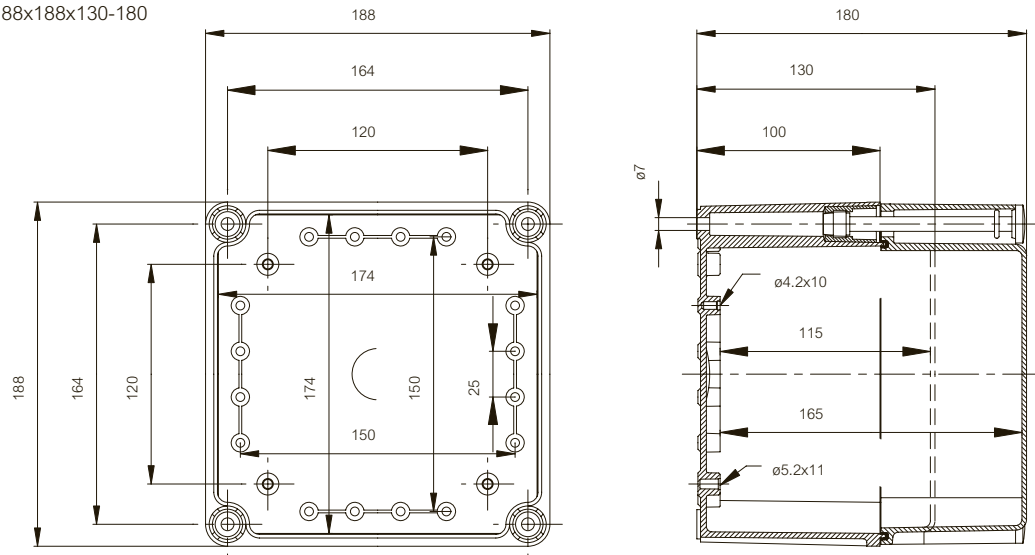

SOLID 278x188x130-180

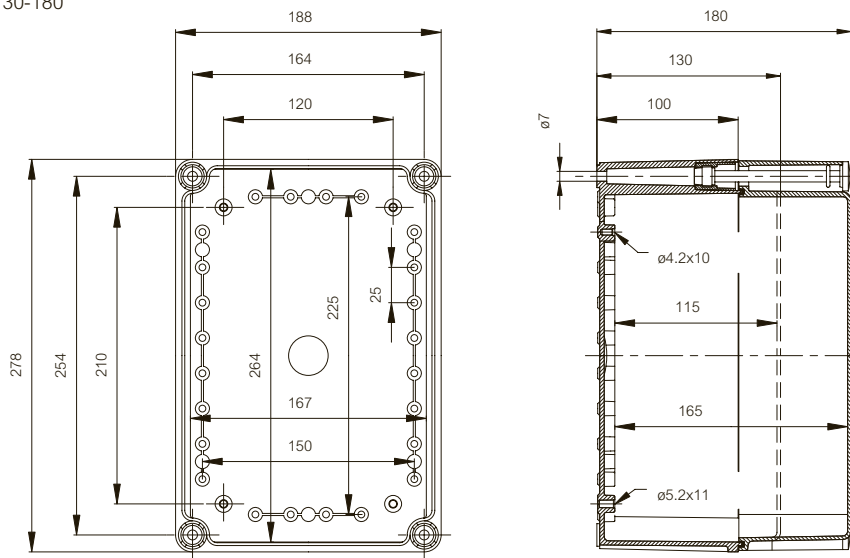

SOLID 378x188x130-180

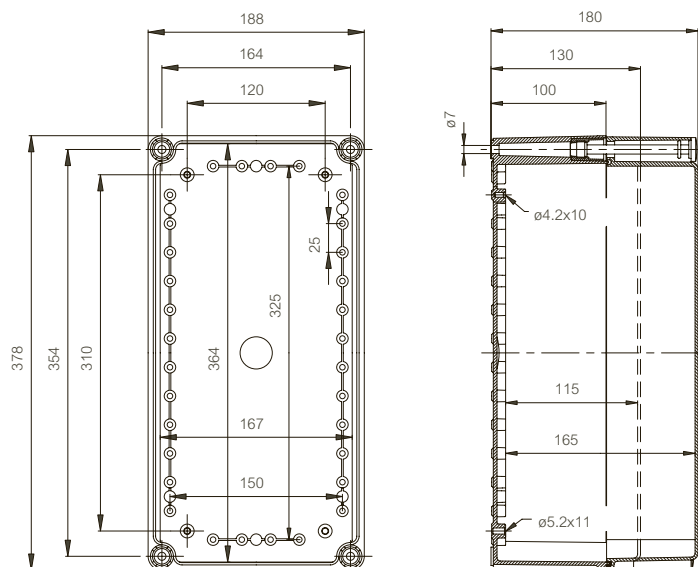

SOLID 278x278x130-180

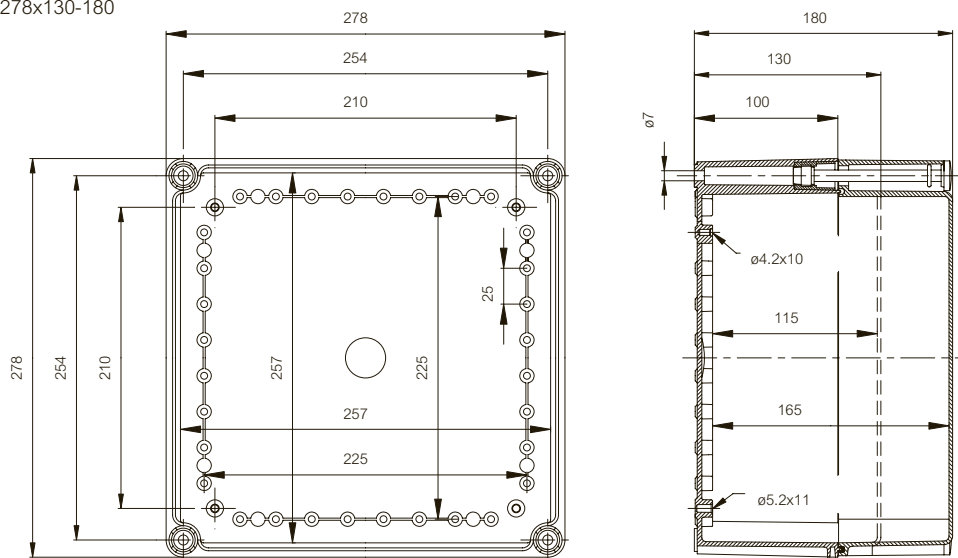

SOLID 378x278x130-180

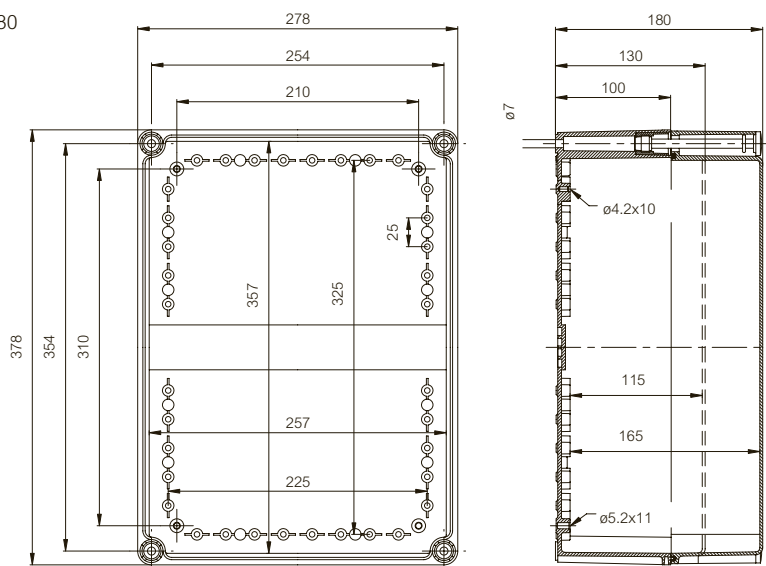

SOLID 558x278x130

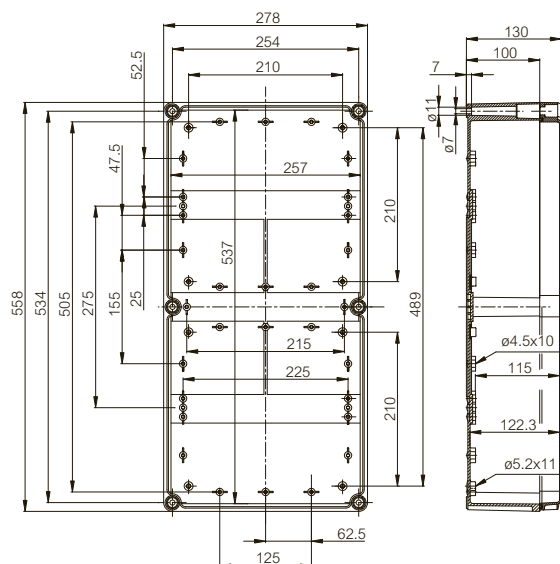

SOLID 558x378x180

