

Kompaktleistungsschalter 3VA2 bis 630 A, ETU, 400/690 V, bis 150 kA

Anlagenschutz

Auswahl- und Bestelldaten

PE (ST, SZ, M) = 1

PKG*/VPE = 1 ST

PG = 12P



Anschluss-technik	Typ	Bemes-sungs-strom I_n	Einstellstrom der strom-abhängig verzögerten Überlast-auslöser "L" I_r	S-Funktion (kurzzeit-verzöger-ter Kurz-schluss-auslöser "S") I_{sd}	Ansprech-strom der un-verzögerten Kurzschluss-auslöser "I" I_i	LK
		A	A	A	A	

I_{cu} bis 55 kA bei 415 V, Mittleres Schaltvermögen M siehe "Übersicht", S. 1/6 und 1/7

Artikel-Nr. www.siemens.com/product?Artikel-Nr. Grundpreis € pro PE

3-polig, Festeinbau, 3VA20 bis 3VA24, bis 630 A Elektronischer Überstromauslöser



l201_18857

Anlagenschutz, ETU320 LI

Mit einstellbarem Überlastauslöser I_r und einstellbarem unverzögerten Kurzschlussauslöser I_i

Anschluss Rahmenklemme

3VA20	25	10 ... 25	--	38 ... 300	B	3VA2025-5HL36-0AA0	486,—
	40	16 ... 40	--	60 ... 480	B	3VA2040-5HL36-0AA0	486,—
	63	25 ... 63	--	95 ... 756	B	3VA2063-5HL36-0AA0	486,—
	100	40 ... 100	--	150 ... 1200	B	3VA2010-5HL36-0AA0	526,—
3VA21	25	10 ... 25	--	38 ... 300	B	3VA2125-5HL36-0AA0	486,—
	40	16 ... 40	--	60 ... 480	B	3VA2140-5HL36-0AA0	486,—
	63	25 ... 63	--	95 ... 756	B	3VA2163-5HL36-0AA0	486,—
	100	40 ... 100	--	150 ... 1200	B	3VA2110-5HL36-0AA0	526,—
	160	63 ... 160	--	240 ... 1600	B	3VA2116-5HL36-0AA0	781,—

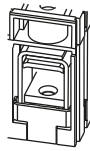

Anschluss Schraubenflächanschluss

3VA20	25	10 ... 25	--	38 ... 300	B	3VA2025-5HL32-0AA0	461,—
	40	16 ... 40	--	60 ... 480	B	3VA2040-5HL32-0AA0	461,—
	63	25 ... 63	--	95 ... 756	B	3VA2063-5HL32-0AA0	461,—
	100	40 ... 100	--	150 ... 1200	B	3VA2010-5HL32-0AA0	501,—
3VA21	25	10 ... 25	--	38 ... 300	B	3VA2125-5HL32-0AA0	461,—
	40	16 ... 40	--	60 ... 480	B	3VA2140-5HL32-0AA0	461,—
	63	25 ... 63	--	95 ... 756	B	3VA2163-5HL32-0AA0	461,—
	100	40 ... 100	--	150 ... 1200	B	3VA2110-5HL32-0AA0	501,—
	160	63 ... 160	--	240 ... 1600	B	3VA2116-5HL32-0AA0	756,—
3VA22	160	63 ... 160	--	240 ... 1920	B	3VA2216-5HL32-0AA0	989,—
	250	100 ... 250	--	375 ... 2500	B	3VA2225-5HL32-0AA0	989,—
3VA23	250	100 ... 250	--	375 ... 3000	B	3VA2325-5HL32-0AA0	1 300,—
	400	160 ... 400	--	600 ... 4000	B	3VA2340-5HL32-0AA0	1 410,—
3VA24	400	160 ... 400	--	600 ... 4800 ¹⁾	B	3VA2440-5HL32-0AA0	1 730,—
	630	250 ... 630	--	945 ... 5670	B	3VA2463-5HL32-0AA0	1 870,—

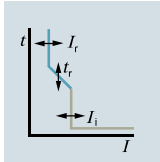
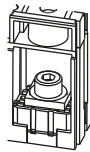

3

¹⁾ bei Schaltvermögen L 4400 A

Kompaktleistungsschalter 3VA2 bis 630 A, ETU, 400/690 V, bis 150 kA

Anlagenschutz

PE (ST, SZ, M) = 1

PKG*/VPE = 1 ST

PG = 12P

Bemes- sungs- strom I_n	LK	I_{cu} bis 85 kA bei 415 V, Hohes Schaltvermögen H H siehe "Übersicht", S. 1/6 und 1/7	Grund- preis € pro PE	LK	I_{cu} bis 110 kA bei 415 V, Sehr hohes Schaltvermögen C C siehe "Übersicht", S. 1/6 und 1/7	Grund- preis € pro PE	LK	I_{cu} bis 150 kA bei 415 V, Extrem hohes Schaltvermögen L L siehe "Übersicht", S. 1/6 und 1/7	Grund- preis € pro PE
A		Artikel-Nr. www.siemens.com/ product?Artikel-Nr.			Artikel-Nr. www.siemens.com/ product?Artikel-Nr.			Artikel-Nr. www.siemens.com/ product?Artikel-Nr.	

Anlagenschutz, ETU320 LIMit einstellbarem Überlastauslöser I_r und einstellbarem unverzögerten Kurzschlussauslöser I_i

Anschluss Rahmenklemme									
25	B	3VA2025-6HL36-0AA0	533,—	B	3VA2025-7HL36-0AA0	627,—	B	3VA2025-8HL36-0AA0	703,—
40	B	3VA2040-6HL36-0AA0	533,—	B	3VA2040-7HL36-0AA0	627,—	B	3VA2040-8HL36-0AA0	703,—
63	B	3VA2063-6HL36-0AA0	533,—	B	3VA2063-7HL36-0AA0	627,—	B	3VA2063-8HL36-0AA0	703,—
100	B	3VA2010-6HL36-0AA0	578,—	B	3VA2010-7HL36-0AA0	679,—	B	3VA2010-8HL36-0AA0	762,—
25	B	3VA2125-6HL36-0AA0	533,—	B	3VA2125-7HL36-0AA0	627,—	B	3VA2125-8HL36-0AA0	703,—
40	B	3VA2140-6HL36-0AA0	533,—	B	3VA2140-7HL36-0AA0	627,—	B	3VA2140-8HL36-0AA0	703,—
63	B	3VA2163-6HL36-0AA0	533,—	B	3VA2163-7HL36-0AA0	627,—	B	3VA2163-8HL36-0AA0	703,—
100	B	3VA2110-6HL36-0AA0	578,—	B	3VA2110-7HL36-0AA0	679,—	B	3VA2110-8HL36-0AA0	762,—
160	B	3VA2116-6HL36-0AA0	847,—	B	3VA2116-7HL36-0AA0	978,—	B	3VA2116-8HL36-0AA0	1 110,—
Anschluss Schraubenflachanschluss									
25	B	3VA2025-6HL32-0AA0	509,—	B	3VA2025-7HL32-0AA0	602,—	B	3VA2025-8HL32-0AA0	678,—
40	B	3VA2040-6HL32-0AA0	509,—	B	3VA2040-7HL32-0AA0	602,—	B	3VA2040-8HL32-0AA0	678,—
63	B	3VA2063-6HL32-0AA0	509,—	B	3VA2063-7HL32-0AA0	602,—	B	3VA2063-8HL32-0AA0	678,—
100	B	3VA2010-6HL32-0AA0	554,—	B	3VA2010-7HL32-0AA0	654,—	B	3VA2010-8HL32-0AA0	738,—
25	B	3VA2125-6HL32-0AA0	509,—	B	3VA2125-7HL32-0AA0	602,—	B	3VA2125-8HL32-0AA0	678,—
40	B	3VA2140-6HL32-0AA0	509,—	B	3VA2140-7HL32-0AA0	602,—	B	3VA2140-8HL32-0AA0	678,—
63	B	3VA2163-6HL32-0AA0	509,—	B	3VA2163-7HL32-0AA0	602,—	B	3VA2163-8HL32-0AA0	678,—
100	B	3VA2110-6HL32-0AA0	554,—	B	3VA2110-7HL32-0AA0	654,—	B	3VA2110-8HL32-0AA0	738,—
160	B	3VA2116-6HL32-0AA0	822,—	B	3VA2116-7HL32-0AA0	953,—	B	3VA2116-8HL32-0AA0	1 090,—
160	B	3VA2216-6HL32-0AA0	1 120,—	B	3VA2216-7HL32-0AA0	1 230,—	B	3VA2216-8HL32-0AA0	1 390,—
250	B	3VA2225-6HL32-0AA0	1 120,—	B	3VA2225-7HL32-0AA0	1 230,—	B	3VA2225-8HL32-0AA0	1 390,—
250	B	3VA2325-6HL32-0AA0	1 540,—	B	3VA2325-7HL32-0AA0	1 550,—	¹⁾ B	3VA2325-8HL32-0AA0	1 850,—
400	B	3VA2340-6HL32-0AA0	1 540,—	B	3VA2340-7HL32-0AA0	1 750,—	¹⁾ B	3VA2340-8HL32-0AA0	2 020,—
400	B	3VA2440-6HL32-0AA0	1 920,—	B	3VA2440-7HL32-0AA0	2 150,—	¹⁾ B	3VA2440-8HL32-0AA0	2 400,—
630	B	3VA2463-6HL32-0AA0	2 100,—	B	3VA2463-7HL32-0AA0	2 340,—	¹⁾ B	3VA2463-8HL32-0AA0	2 600,—

¹⁾ Liefereinsatz voraussichtlich 3. Quartal 2015

Kompaktleistungsschalter 3VA2 bis 630 A, ETU, 400/690 V, bis 150 kA

Anlagenschutz

PE (ST, SZ, M) = 1

PKG*/VPE = 1 ST

PG = 12P



Anschluss-technik	Typ	Bemes-sungs-strom I_n	Einstellstrom der strom-abhängig verzögerten Überlast-auslöser "L" I_r	Ansprech-strom der un-verzögerten Kurzschluss-auslöser "I" I_i	Erd-schluss-schutz G I_g	LK
		A	A	A	A	

I_{cu} bis 55 kA bei 415 V, Mittleres Schaltvermögen M
siehe "Übersicht", S. 1/6 und 1/7

Artikel-Nr.
[www.siemens.com/
product?Artikel-Nr.](http://www.siemens.com/product?Artikel-Nr.)

Grund-
preis €
pro PE

3-polig, Festeinbau, 3VA20 bis 3VA24, bis 630 A Elektronischer Überstromauslöser



I201_18426

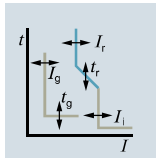

Anlagenschutz, ETU330 LIG

Mit einstellbarem Überlastauslöser I_r , einstellbarem unverzögerten Kurzschlussauslöser I_i und einstellbarem Erdschlussauslöser I_g

Anschluss Rahmenklemme

Typ	I_n	I_r	I_i	I_g	LK	Artikel-Nr.	Preis
3VA20	25	10 ... 25	38 ... 300	15 ... 25	B	3VA2025-5HM36-0AA0	740,—
	40	16 ... 40	60 ... 480	16 ... 40	B	3VA2040-5HM36-0AA0	740,—
	63	25 ... 63	95 ... 756	16 ... 63	B	3VA2063-5HM36-0AA0	740,—
	100	40 ... 100	150 ... 1200	20 ... 100	B	3VA2010-5HM36-0AA0	780,—
3VA21	25	10 ... 25	38 ... 300	15 ... 25	B	3VA2125-5HM36-0AA0	740,—
	40	16 ... 40	60 ... 480	16 ... 40	B	3VA2140-5HM36-0AA0	740,—
	63	25 ... 63	95 ... 756	16 ... 63	B	3VA2163-5HM36-0AA0	740,—
	100	40 ... 100	150 ... 1200	20 ... 100	B	3VA2110-5HM36-0AA0	780,—
	160	63 ... 160	240 ... 1600	32 ... 160	B	3VA2116-5HM36-0AA0	1 040,—

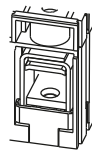

Anschluss Schraubenflanschanschluss

Typ	I_n	I_r	I_i	I_g	LK	Artikel-Nr.	Preis
3VA20	25	10 ... 25	38 ... 300	15 ... 25	B	3VA2025-5HM32-0AA0	716,—
	40	16 ... 40	60 ... 480	16 ... 40	B	3VA2040-5HM32-0AA0	716,—
	63	25 ... 63	95 ... 756	16 ... 63	B	3VA2063-5HM32-0AA0	716,—
	100	40 ... 100	150 ... 1200	20 ... 100	B	3VA2010-5HM32-0AA0	756,—
3VA21	25	10 ... 25	38 ... 300	15 ... 25	B	3VA2125-5HM32-0AA0	716,—
	40	16 ... 40	60 ... 480	16 ... 40	B	3VA2140-5HM32-0AA0	716,—
	63	25 ... 63	95 ... 756	16 ... 63	B	3VA2163-5HM32-0AA0	716,—
	100	40 ... 100	150 ... 1200	20 ... 100	B	3VA2110-5HM32-0AA0	756,—
	160	63 ... 160	240 ... 1600	32 ... 160	B	3VA2116-5HM32-0AA0	1 010,—
3VA22	160	63 ... 160	240 ... 1920	32 ... 160	B	3VA2216-5HM32-0AA0	1 250,—
	250	100 ... 250	375 ... 2500	50 ... 250	B	3VA2225-5HM32-0AA0	1 250,—
3VA23	250	100 ... 250	375 ... 3000	50 ... 250	B	3VA2325-5HM32-0AA0	1 550,—
	400	160 ... 400	600 ... 4000	80 ... 400	B	3VA2340-5HM32-0AA0	1 660,—
3VA24	400	160 ... 400	600 ... 4800 ¹⁾	80 ... 400	B	3VA2440-5HM32-0AA0	1 990,—
	630	250 ... 630	945 ... 5670	126 ... 630	B	3VA2463-5HM32-0AA0	2 100,—

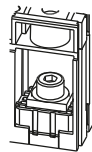

¹⁾ bei Schaltvermögen L 4400 A

Kompaktleistungsschalter 3VA2 bis 630 A, ETU, 400/690 V, bis 150 kA

Anlagenschutz

PE (ST, SZ, M) = 1

PKG*/VPE = 1 ST

PG = 12P

Bemes- sungs- strom I_n	LK	I_{cu} bis 85 kA bei 415 V, Hohes Schaltvermögen H siehe "Übersicht", S. 1/6 und 1/7	(H)	LK	I_{cu} bis 110 kA bei 415 V, Sehr hohes Schaltvermögen C siehe "Übersicht", S. 1/6 und 1/7	(C)	LK	I_{cu} bis 150 kA bei 415 V, Extrem hohes Schaltvermögen L siehe "Übersicht", S. 1/6 und 1/7	(L)
A		Artikel-Nr. www.siemens.com/ product?Artikel-Nr.	Grund- preis € pro PE		Artikel-Nr. www.siemens.com/ product?Artikel-Nr.	Grund- preis € pro PE		Artikel-Nr. www.siemens.com/ product?Artikel-Nr.	Grund- preis € pro PE

Anlagenschutz, ETU330 LIG

Mit einstellbarem Überlastauslöser I_r , einstellbarem unverzögerten Kurzschlussauslöser I_i und einstellbarem Erdschlussauslöser I_G

Anschluss Rahmenklemme

25	B	3VA2025-6HM36-0AA0	788,—	B	3VA2025-7HM36-0AA0	882,—	B	3VA2025-8HM36-0AA0	958,—
40	B	3VA2040-6HM36-0AA0	788,—	B	3VA2040-7HM36-0AA0	882,—	B	3VA2040-8HM36-0AA0	958,—
63	B	3VA2063-6HM36-0AA0	788,—	B	3VA2063-7HM36-0AA0	882,—	B	3VA2063-8HM36-0AA0	958,—
100	B	3VA2010-6HM36-0AA0	832,—	B	3VA2010-7HM36-0AA0	934,—	B	3VA2010-8HM36-0AA0	1 020,—
25	B	3VA2125-6HM36-0AA0	788,—	B	3VA2125-7HM36-0AA0	882,—	B	3VA2125-8HM36-0AA0	958,—
40	B	3VA2140-6HM36-0AA0	788,—	B	3VA2140-7HM36-0AA0	882,—	B	3VA2140-8HM36-0AA0	958,—
63	B	3VA2163-6HM36-0AA0	788,—	B	3VA2163-7HM36-0AA0	882,—	B	3VA2163-8HM36-0AA0	958,—
100	B	3VA2110-6HM36-0AA0	832,—	B	3VA2110-7HM36-0AA0	934,—	B	3VA2110-8HM36-0AA0	1 020,—
160	B	3VA2116-6HM36-0AA0	1 100,—	B	3VA2116-7HM36-0AA0	1 220,—	B	3VA2116-8HM36-0AA0	1 370,—

Anschluss Schraubenflachanschluss

25	B	3VA2025-6HM32-0AA0	764,—	B	3VA2025-7HM32-0AA0	857,—	B	3VA2025-8HM32-0AA0	933,—
40	B	3VA2040-6HM32-0AA0	764,—	B	3VA2040-7HM32-0AA0	857,—	B	3VA2040-8HM32-0AA0	933,—
63	B	3VA2063-6HM32-0AA0	764,—	B	3VA2063-7HM32-0AA0	857,—	B	3VA2063-8HM32-0AA0	933,—
100	B	3VA2010-6HM32-0AA0	808,—	B	3VA2010-7HM32-0AA0	910,—	B	3VA2010-8HM32-0AA0	992,—
25	B	3VA2125-6HM32-0AA0	764,—	B	3VA2125-7HM32-0AA0	857,—	B	3VA2125-8HM32-0AA0	933,—
40	B	3VA2140-6HM32-0AA0	764,—	B	3VA2140-7HM32-0AA0	857,—	B	3VA2140-8HM32-0AA0	933,—
63	B	3VA2163-6HM32-0AA0	764,—	B	3VA2163-7HM32-0AA0	857,—	B	3VA2163-8HM32-0AA0	933,—
100	B	3VA2110-6HM32-0AA0	808,—	B	3VA2110-7HM32-0AA0	910,—	B	3VA2110-8HM32-0AA0	992,—
160	B	3VA2116-6HM32-0AA0	1 080,—	B	3VA2116-7HM32-0AA0	1 200,—	B	3VA2116-8HM32-0AA0	1 350,—
160	B	3VA2216-6HM32-0AA0	1 380,—	B	3VA2216-7HM32-0AA0	1 480,—	B	3VA2216-8HM32-0AA0	1 650,—
250	B	3VA2225-6HM32-0AA0	1 380,—	B	3VA2225-7HM32-0AA0	1 480,—	B	3VA2225-8HM32-0AA0	1 650,—
250	B	3VA2325-6HM32-0AA0	1 800,—	B	3VA2325-7HM32-0AA0	1 810,—	¹⁾ B	3VA2325-8HM32-0AA0	2 110,—
400	B	3VA2340-6HM32-0AA0	1 800,—	B	3VA2340-7HM32-0AA0	2 010,—	¹⁾ B	3VA2340-8HM32-0AA0	2 270,—
400	B	3VA2440-6HM32-0AA0	2 170,—	B	3VA2440-7HM32-0AA0	2 400,—	¹⁾ B	3VA2440-8HM32-0AA0	2 650,—
630	B	3VA2463-6HM32-0AA0	2 360,—	B	3VA2463-7HM32-0AA0	2 580,—	¹⁾ B	3VA2463-8HM32-0AA0	2 860,—

¹⁾ Liefereinsatz voraussichtlich 3. Quartal 2015

Kompaktleistungsschalter 3VA2 bis 630 A, ETU, 400/690 V, bis 150 kA

Anlagenschutz

PE (ST, SZ, M) = 1

PKG*/VPE = 1 ST

PG = 12P



Anschluss-technik	Typ	Bemes-sungs-strom I_n	Einstellstrom der stromabhängig verzögerten Überlastauslöser "L" I_r	Ansprechstrom der unverzögerten Kurzschlussauslöser "I" I_i	LK
		A	A	A	

I_{cu} bis 55 kA bei 415 V, Mittleres Schaltvermögen M M
siehe "Übersicht", S. 1/6 und 1/7

Artikel-Nr. www.siemens.com/product?Artikel-Nr. Grundpreis € pro PE

3-polig, Festeinbau, 3VA21 bis 3VA24, bis 630 A Elektronischer Überstromauslöser



1201_18427

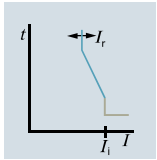

Anlagenschutz, ETU340 ELISA

Mit einfach einstellbarer Kennlinie (Kennlinienform einer Sicherung)

Anschluss Rahmenklemme

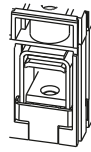

3VA21	25	10 ... 25	375	B	3VA2125-5HK36-0AA0	485,—
	40	16 ... 40	600	B	3VA2140-5HK36-0AA0	485,—
	63	25 ... 63	945	B	3VA2163-5HK36-0AA0	485,—
	100	40 ... 100	1500	B	3VA2110-5HK36-0AA0	526,—

Anschluss Schraubenflanschanschluss

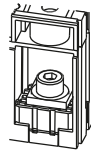

3VA21	25	10 ... 25	375	B	3VA2125-5HK32-0AA0	461,—
	40	16 ... 40	600	B	3VA2140-5HK32-0AA0	461,—
	63	25 ... 63	945	B	3VA2163-5HK32-0AA0	461,—
	100	40 ... 100	1500	B	3VA2110-5HK32-0AA0	501,—
3VA22	160	63 ... 160	2400	B	3VA2216-5HK32-0AA0	989,—
3VA23	250	100 ... 250	3750	B	3VA2325-5HK32-0AA0	1 290,—
3VA24	400	160 ... 400	6000 ¹⁾	B	3VA2440-5HK32-0AA0	1 730,—
	500	200 ... 500	7000	B	3VA2450-5HK32-0AA0	1 840,—
	630	250 ... 630	5670	B	3VA2463-5HK32-0AA0	1 880,—

¹⁾ bei Schaltvermögen L 4400 A

3

Kompaktleistungsschalter 3VA2 bis 630 A, ETU, 400/690 V, bis 150 kA

Anlagenschutz

PE (ST, SZ, M) = 1

PKG*/VPE = 1 ST

PG = 12P

Bemes- sungs- strom I_n	LK	I_{cu} bis 85 kA bei 415 V, Hohes Schaltvermögen H H		LK	I_{cu} bis 110 kA bei 415 V, Sehr hohes Schaltvermögen C C		LK	I_{cu} bis 150 kA bei 415 V, Extrem hohes Schaltvermögen L L	
		siehe "Übersicht", S. 1/6 und 1/7			siehe "Übersicht", S. 1/6 und 1/7			siehe "Übersicht", S. 1/6 und 1/7	
A		Artikel-Nr. www.siemens.com/ product?Artikel-Nr.	Grund- preis € pro PE	Artikel-Nr. www.siemens.com/ product?Artikel-Nr.	Grund- preis € pro PE	Artikel-Nr. www.siemens.com/ product?Artikel-Nr.	Grund- preis € pro PE		

Anlagenschutz, ETU340 ELISA

Mit einfach einstellbarer Kennlinie (Kennlinienform einer Sicherung)

Anschluss Rahmenklemme

25	B	3VA2125-6HK36-0AA0	534,—	B	3VA2125-7HK36-0AA0	627,—	B	3VA2125-8HK36-0AA0	703,—
40	B	3VA2140-6HK36-0AA0	534,—	B	3VA2140-7HK36-0AA0	627,—	B	3VA2140-8HK36-0AA0	703,—
63	B	3VA2163-6HK36-0AA0	534,—	B	3VA2163-7HK36-0AA0	627,—	B	3VA2163-8HK36-0AA0	703,—
100	B	3VA2110-6HK36-0AA0	578,—	B	3VA2110-7HK36-0AA0	679,—	B	3VA2110-8HK36-0AA0	762,—

Anschluss Schraubenflachanschluss

25	B	3VA2125-6HK32-0AA0	509,—	B	3VA2125-7HK32-0AA0	602,—	B	3VA2125-8HK32-0AA0	679,—
40	B	3VA2140-6HK32-0AA0	509,—	B	3VA2140-7HK32-0AA0	602,—	B	3VA2140-8HK32-0AA0	679,—
63	B	3VA2163-6HK32-0AA0	509,—	B	3VA2163-7HK32-0AA0	602,—	B	3VA2163-8HK32-0AA0	679,—
100	B	3VA2110-6HK32-0AA0	553,—	B	3VA2110-7HK32-0AA0	655,—	B	3VA2110-8HK32-0AA0	738,—
160	B	3VA2216-6HK32-0AA0	1 120,—	B	3VA2216-7HK32-0AA0	1 230,—	B	3VA2216-8HK32-0AA0	1 390,—
250	B	3VA2325-6HK32-0AA0	1 540,—	B	3VA2325-7HK32-0AA0	1 560,—	¹⁾ B	3VA2325-8HK32-0AA0	1 860,—
400	B	3VA2440-6HK32-0AA0	1 920,—	B	3VA2440-7HK32-0AA0	2 150,—	¹⁾ B	3VA2440-8HK32-0AA0	2 400,—
500	B	3VA2450-6HK32-0AA0	2 100,—	B	3VA2450-7HK32-0AA0	2 270,—	¹⁾ B	3VA2450-8HK32-0AA0	2 610,—
630	B	3VA2463-6HK32-0AA0	2 090,—	B	3VA2463-7HK32-0AA0	2 330,—	¹⁾ B	3VA2463-8HK32-0AA0	2 610,—

¹⁾ Liefereinsatz voraussichtlich 3. Quartal 2015

Kompaktleistungsschalter 3VA2 bis 630 A, ETU, 400/690 V, bis 150 kA

Anlagenschutz

PE (ST, SZ, M) = 1

PKG*/VPE = 1 ST

PG = 12P



Anschlusstechnik	Typ	Bemessungsstrom I_n	Einstellstrom der stromabhängig verzögerten Überlastauslöser "L" I_r	S-Funktion (kurzzeitverzögerter Kurzschlusschutz "S") I_{sd}	Ansprechstrom der unverzögerten Kurzschlussauslöser "I" I_i	LK
		A	A	A	A	

I_{cu} bis 55 kA bei 415 V, Mittleres Schaltvermögen M (M)
siehe "Übersicht", S. 1/6 und 1/7

Artikel-Nr. www.siemens.com/product?Artikel-Nr. Grundpreis € pro PE

3-polig, Festeinbau, 3VA20 bis 3VA24, bis 630 A Elektronischer Überstromauslöser

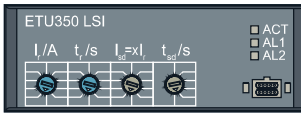

I201_18430

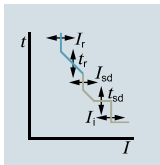

Anlagen- und Generatorschutz, ETU350 LSI

Mit einstellbarem Überlastauslöser I_r , einstellbarem verzögerten Kurzschlussauslöser I_{sd} und fest eingestelltem unverzögerten Kurzschlussauslöser I_i

$I_r \times \dots$

Anschluss Rahmenklemme

3VA20	25	10 ... 25	1,5 ... 10	300	B	3VA2025-5HN36-0AA0	537,—
	40	16 ... 40	1,5 ... 10	480	B	3VA2040-5HN36-0AA0	537,—
	63	25 ... 63	1,5 ... 10	756	B	3VA2063-5HN36-0AA0	537,—
	100	40 ... 100	1,5 ... 10	1200	B	3VA2010-5HN36-0AA0	581,—
3VA21	25	10 ... 25	1,5 ... 10	300	B	3VA2125-5HN36-0AA0	537,—
	40	16 ... 40	1,5 ... 10	480	B	3VA2140-5HN36-0AA0	537,—
	63	25 ... 63	1,5 ... 10	756	B	3VA2163-5HN36-0AA0	537,—
	100	40 ... 100	1,5 ... 10	1200	B	3VA2110-5HN36-0AA0	581,—
	160	63 ... 160	1,5 ... 10	1600	B	3VA2116-5HN36-0AA0	872,—

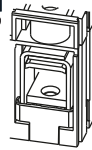

Anschluss Schraubenflächanschluss

3VA20	25	10 ... 25	1,5 ... 10	300	B	3VA2025-5HN32-0AA0	512,—
	40	16 ... 40	1,5 ... 10	480	B	3VA2040-5HN32-0AA0	512,—
	63	25 ... 63	1,5 ... 10	756	B	3VA2063-5HN32-0AA0	512,—
	100	40 ... 100	1,5 ... 10	1200	B	3VA2010-5HN32-0AA0	557,—
3VA21	25	10 ... 25	1,5 ... 10	300	B	3VA2125-5HN32-0AA0	512,—
	40	16 ... 40	1,5 ... 10	480	B	3VA2140-5HN32-0AA0	512,—
	63	25 ... 63	1,5 ... 10	756	B	3VA2163-5HN32-0AA0	512,—
	100	40 ... 100	1,5 ... 10	1200	B	3VA2110-5HN32-0AA0	557,—
	160	63 ... 160	1,5 ... 10	1600	B	3VA2116-5HN32-0AA0	847,—
3VA22	160	63 ... 160	1,5 ... 10	1920	B	3VA2216-5HN32-0AA0	1 090,—
	250	100 ... 250	1,5 ... 10	2500	B	3VA2225-5HN32-0AA0	1 090,—
3VA23	250	100 ... 250	1,5 ... 10	3000	B	3VA2325-5HN32-0AA0	1 460,—
	400	160 ... 400	1,5 ... 10	4000	B	3VA2340-5HN32-0AA0	1 580,—
3VA24	400	160 ... 400	1,5 ... 10	4800 ¹⁾	B	3VA2440-5HN32-0AA0	1 940,—
	630	250 ... 630	1,5 ... 9	5670	B	3VA2463-5HN32-0AA0	2 090,—

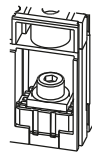

¹⁾ bei Schaltvermögen L 4400 A

Kompaktleistungsschalter 3VA2 bis 630 A, ETU, 400/690 V, bis 150 kA

Anlagenschutz

PE (ST, SZ, M) = 1

PKG*/VPE = 1 ST

PG = 12P

Bemes- sungs- strom I_n	LK	I_{cu} bis 85 kA bei 415 V, Hohes Schaltvermögen H H	Grund- preis € pro PE	LK	I_{cu} bis 110 kA bei 415 V, Sehr hohes Schaltvermögen C C	Grund- preis € pro PE	LK	I_{cu} bis 150 kA bei 415 V, Extrem hohes Schaltvermögen L L	Grund- preis € pro PE
A		Artikel-Nr. www.siemens.com/ product?Artikel-Nr.			Artikel-Nr. www.siemens.com/ product?Artikel-Nr.			Artikel-Nr. www.siemens.com/ product?Artikel-Nr.	

Anlagen- und Generatorschutz, ETU350 LSI

Mit einstellbarem Überlastauslöser I_n , einstellbarem verzögerten Kurzschlussauslöser I_{sg} und fest eingestelltem unverzögerten Kurzschlussauslöser I_i

Anschluss Rahmenklemme

25	B	3VA2025-6HN36-0AA0	590,—	B	3VA2025-7HN36-0AA0	694,—	B	3VA2025-8HN36-0AA0	779,—
40	B	3VA2040-6HN36-0AA0	590,—	B	3VA2040-7HN36-0AA0	694,—	B	3VA2040-8HN36-0AA0	779,—
63	B	3VA2063-6HN36-0AA0	590,—	B	3VA2063-7HN36-0AA0	694,—	B	3VA2063-8HN36-0AA0	779,—
100	B	3VA2010-6HN36-0AA0	639,—	B	3VA2010-7HN36-0AA0	752,—	B	3VA2010-8HN36-0AA0	844,—
25	B	3VA2125-6HN36-0AA0	590,—	B	3VA2125-7HN36-0AA0	694,—	B	3VA2125-8HN36-0AA0	779,—
40	B	3VA2140-6HN36-0AA0	590,—	B	3VA2140-7HN36-0AA0	694,—	B	3VA2140-8HN36-0AA0	779,—
63	B	3VA2163-6HN36-0AA0	590,—	B	3VA2163-7HN36-0AA0	694,—	B	3VA2163-8HN36-0AA0	779,—
100	B	3VA2110-6HN36-0AA0	639,—	B	3VA2110-7HN36-0AA0	752,—	B	3VA2110-8HN36-0AA0	844,—
160	B	3VA2116-6HN36-0AA0	938,—	B	3VA2116-7HN36-0AA0	1 080,—	B	3VA2116-8HN36-0AA0	1 220,—

Anschluss Schraubenflachanschluss

25	B	3VA2025-6HN32-0AA0	566,—	B	3VA2025-7HN32-0AA0	669,—	B	3VA2025-8HN32-0AA0	754,—
40	B	3VA2040-6HN32-0AA0	566,—	B	3VA2040-7HN32-0AA0	669,—	B	3VA2040-8HN32-0AA0	754,—
63	B	3VA2063-6HN32-0AA0	566,—	B	3VA2063-7HN32-0AA0	669,—	B	3VA2063-8HN32-0AA0	754,—
100	B	3VA2010-6HN32-0AA0	614,—	B	3VA2010-7HN32-0AA0	728,—	B	3VA2010-8HN32-0AA0	819,—
25	B	3VA2125-6HN32-0AA0	566,—	B	3VA2125-7HN32-0AA0	669,—	B	3VA2125-8HN32-0AA0	754,—
40	B	3VA2140-6HN32-0AA0	566,—	B	3VA2140-7HN32-0AA0	669,—	B	3VA2140-8HN32-0AA0	754,—
63	B	3VA2163-6HN32-0AA0	566,—	B	3VA2163-7HN32-0AA0	669,—	B	3VA2163-8HN32-0AA0	754,—
100	B	3VA2110-6HN32-0AA0	614,—	B	3VA2110-7HN32-0AA0	728,—	B	3VA2110-8HN32-0AA0	819,—
160	B	3VA2116-6HN32-0AA0	914,—	B	3VA2116-7HN32-0AA0	1 060,—	B	3VA2116-8HN32-0AA0	1 190,—
160	B	3VA2216-6HN32-0AA0	1 250,—	B	3VA2216-7HN32-0AA0	1 370,—	B	3VA2216-8HN32-0AA0	1 540,—
250	B	3VA2225-6HN32-0AA0	1 250,—	B	3VA2225-7HN32-0AA0	1 370,—	B	3VA2225-8HN32-0AA0	1 540,—
250	B	3VA2325-6HN32-0AA0	1 580,—	B	3VA2325-7HN32-0AA0	1 730,—	¹⁾ B	3VA2325-8HN32-0AA0	2 010,—
400	B	3VA2340-6HN32-0AA0	1 730,—	B	3VA2340-7HN32-0AA0	1 880,—	¹⁾ B	3VA2340-8HN32-0AA0	2 170,—
400	B	3VA2440-6HN32-0AA0	2 130,—	B	3VA2440-7HN32-0AA0	2 320,—	¹⁾ B	3VA2440-8HN32-0AA0	2 590,—
630	B	3VA2463-6HN32-0AA0	2 320,—	B	3VA2463-7HN32-0AA0	2 520,—	¹⁾ B	3VA2463-8HN32-0AA0	2 820,—

¹⁾ Liefereinsatz voraussichtlich 3. Quartal 2015

Kompaktleistungsschalter 3VA2 bis 630 A, ETU, 400/690 V, bis 150 kA

Anlagenschutz

PE (ST, SZ, M) = 1

PKG*/VPE = 1 ST

PG = 12P



Anschluss-technik	Typ	Bemessungsstrom I_n	Einstellstrom der stromabhängig verzögerten Überlastauslöser "L" I_r	S-Funktion (kurzzeitverzögerten Kurzschlusschutz "S") I_{sd}	Ansprechstrom der unverzögerten Kurzschlussauslöser "I" I_i	LK
		A	A	A	A	

I_{cu} bis 55 kA bei 415 V, Mittleres Schaltvermögen M
siehe "Übersicht", S. 1/6 und 1/7

Artikel-Nr. www.siemens.com/product?Artikel-Nr. Grundpreis € pro PE

3-polig, Festeinbau, 3VA20 bis 3VA24, bis 630 A Elektronischer Überstromauslöser



1201_18480

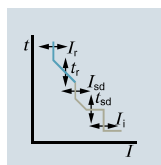

Anlagen- und Generatorschutz, mit Anzeige, ETU550 LSI

Mit einstellbarem Überlastauslöser I_r , einstellbarem verzögerten Kurzschlussauslöser I_{sd} und einstellbarem unverzögerten Kurzschlussauslöser I_i

Anschluss Rahmenklemme

3VA20	25	10 ... 25	15 ... 250	38 ... 300	B	3VA2025-5JP36-0AA0	962,—
	40	16 ... 40	24 ... 400	60 ... 480	B	3VA2040-5JP36-0AA0	962,—
	63	25 ... 63	38 ... 630	95 ... 756	B	3VA2063-5JP36-0AA0	962,—
	100	40 ... 100	60 ... 1000	150 ... 1200	B	3VA2010-5JP36-0AA0	1 010,—
3VA21	25	10 ... 25	15 ... 250	38 ... 300	B	3VA2125-5JP36-0AA0	962,—
	40	16 ... 40	24 ... 400	60 ... 480	B	3VA2140-5JP36-0AA0	962,—
	63	25 ... 63	38 ... 630	95 ... 756	B	3VA2163-5JP36-0AA0	962,—
	100	40 ... 100	60 ... 1000	150 ... 1200	B	3VA2110-5JP36-0AA0	1 010,—
	160	63 ... 160	96 ... 1600	240 ... 1600	B	3VA2116-5JP36-0AA0	1 300,—



Anschluss Schraubenflächanschluss

3VA20	25	10 ... 25	15 ... 250	38 ... 300	B	3VA2025-5JP32-0AA0	937,—
	40	16 ... 40	24 ... 400	60 ... 480	B	3VA2040-5JP32-0AA0	937,—
	63	25 ... 63	38 ... 630	95 ... 756	B	3VA2063-5JP32-0AA0	937,—
	100	40 ... 100	60 ... 1000	150 ... 1200	B	3VA2010-5JP32-0AA0	983,—
3VA21	25	10 ... 25	15 ... 250	38 ... 300	B	3VA2125-5JP32-0AA0	937,—
	40	16 ... 40	24 ... 400	60 ... 480	B	3VA2140-5JP32-0AA0	937,—
	63	25 ... 63	38 ... 630	95 ... 756	B	3VA2163-5JP32-0AA0	937,—
	100	40 ... 100	60 ... 1000	150 ... 1200	B	3VA2110-5JP32-0AA0	983,—
	160	63 ... 160	96 ... 1600	240 ... 1600	B	3VA2116-5JP32-0AA0	1 270,—
3VA22	160	63 ... 160	96 ... 1600	240 ... 1920	B	3VA2216-5JP32-0AA0	1 510,—
	250	100 ... 250	150 ... 2500	375 ... 2500	B	3VA2225-5JP32-0AA0	1 510,—
3VA23	250	100 ... 250	150 ... 2500	375 ... 3000	B	3VA2325-5JP32-0AA0	1 880,—
	400	160 ... 400	240 ... 4000	600 ... 4000	B	3VA2340-5JP32-0AA0	2 010,—
3VA24	400	160 ... 400	240 ... 4000	600 ... 6000 ¹⁾	B	3VA2440-5JP32-0AA0	2 370,—
	500	200 ... 500	300 ... 5000	750 ... 7000	B	3VA2450-5JP32-0AA0	2 370,—
	630	250 ... 630	378 ... 5670	945 ... 5670	B	3VA2463-5JP32-0AA0	2 510,—

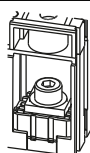

1201_18481

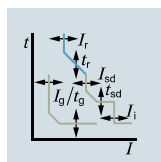

Anlagen- und Generatorschutz, mit Anzeige, ETU560 LSI

Mit einstellbarem Überlastauslöser I_r , einstellbarem verzögerten Kurzschlussauslöser I_{sd} , einstellbarem unverzögerten Kurzschlussauslöser I_i und einstellbarem Erdschlussauslöser I_g

Anschluss Rahmenklemme

3VA20	25	10 ... 25	15 ... 250	38 ... 300	B	3VA2025-5JQ36-0AA0	1 210,—
	40	16 ... 40	24 ... 400	60 ... 480	B	3VA2040-5JQ36-0AA0	1 210,—
	63	25 ... 63	38 ... 630	95 ... 756	B	3VA2063-5JQ36-0AA0	1 210,—
	100	40 ... 100	60 ... 1000	150 ... 1200	B	3VA2010-5JQ36-0AA0	1 270,—
3VA21	25	10 ... 25	15 ... 250	38 ... 300	B	3VA2125-5JQ36-0AA0	1 210,—
	40	16 ... 40	24 ... 400	60 ... 480	B	3VA2140-5JQ36-0AA0	1 210,—
	63	25 ... 63	38 ... 630	95 ... 756	B	3VA2163-5JQ36-0AA0	1 210,—
	100	40 ... 100	60 ... 1000	150 ... 1200	B	3VA2110-5JQ36-0AA0	1 270,—
	160	63 ... 160	96 ... 1600	240 ... 1600	B	3VA2116-5JQ36-0AA0	1 540,—

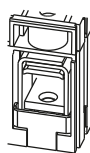

Anschluss Schraubenflächanschluss

3VA20	25	10 ... 25	15 ... 250	38 ... 300	B	3VA2025-5JQ32-0AA0	1 190,—
	40	16 ... 40	24 ... 400	60 ... 480	B	3VA2040-5JQ32-0AA0	1 190,—
	63	25 ... 63	38 ... 630	95 ... 756	B	3VA2063-5JQ32-0AA0	1 190,—
	100	40 ... 100	60 ... 1000	150 ... 1200	B	3VA2010-5JQ32-0AA0	1 230,—
3VA21	25	10 ... 25	15 ... 250	38 ... 300	B	3VA2125-5JQ32-0AA0	1 190,—
	40	16 ... 40	24 ... 400	60 ... 480	B	3VA2140-5JQ32-0AA0	1 190,—
	63	25 ... 63	38 ... 630	95 ... 756	B	3VA2163-5JQ32-0AA0	1 190,—
	100	40 ... 100	60 ... 1000	150 ... 1200	B	3VA2110-5JQ32-0AA0	1 230,—
	160	63 ... 160	96 ... 1600	240 ... 1600	B	3VA2116-5JQ32-0AA0	1 520,—
3VA22	160	63 ... 160	96 ... 1600	240 ... 1920	B	3VA2216-5JQ32-0AA0	1 770,—
	250	100 ... 250	150 ... 2500	375 ... 2500	B	3VA2225-5JQ32-0AA0	1 770,—
3VA23	250	100 ... 250	150 ... 2500	375 ... 3000	B	3VA2325-5JQ32-0AA0	2 140,—
	400	160 ... 400	240 ... 4000	600 ... 4000	B	3VA2340-5JQ32-0AA0	2 260,—
3VA24	400	160 ... 400	240 ... 4000	600 ... 6000 ¹⁾	B	3VA2440-5JQ32-0AA0	2 620,—
	500	200 ... 500	300 ... 5000	750 ... 7000	B	3VA2450-5JQ32-0AA0	2 620,—
	630	250 ... 630	378 ... 5670	945 ... 5670	B	3VA2463-5JQ32-0AA0	2 770,—

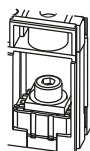

¹⁾ bei Schaltvermögen L 4400 A

Kompaktleistungsschalter 3VA2 bis 630 A, ETU, 400/690 V, bis 150 kA

Anlagenschutz

PE (ST, SZ, M) = 1

PKG*/VPE = 1 ST

PG = 12P

Bemes- sungs- strom I_n	LK	I_{cu} bis 85 kA bei 415 V, Hohes Schaltvermögen H H	Grund- preis € pro PE	LK	I_{cu} bis 110 kA bei 415 V, Sehr hohes Schaltvermögen C C	Grund- preis € pro PE	LK	I_{cu} bis 150 kA bei 415 V, Extrem hohes Schaltvermögen L L	Grund- preis € pro PE
A		Artikel-Nr. www.siemens.com/ product?Artikel-Nr.			Artikel-Nr. www.siemens.com/ product?Artikel-Nr.			Artikel-Nr. www.siemens.com/ product?Artikel-Nr.	

Anlagen- und Generatorschutz, mit Anzeige, ETU550 LSIMit einstellbarem Überlastauslöser I_r , einstellbarem verzögerten Kurzschlussauslöser I_{sd} und einstellbarem unverzögerten Kurzschlussauslöser I_i **Anschluss Rahmenklemme**

25	B	3VA2025-6JP36-0AA0	1 020,—	B	3VA2025-7JP36-0AA0	1 120,—	B	3VA2025-8JP36-0AA0	1 200,—
40	B	3VA2040-6JP36-0AA0	1 020,—	B	3VA2040-7JP36-0AA0	1 120,—	B	3VA2040-8JP36-0AA0	1 200,—
63	B	3VA2063-6JP36-0AA0	1 020,—	B	3VA2063-7JP36-0AA0	1 120,—	B	3VA2063-8JP36-0AA0	1 200,—
100	B	3VA2010-6JP36-0AA0	1 070,—	B	3VA2010-7JP36-0AA0	1 170,—	B	3VA2010-8JP36-0AA0	1 270,—
25	B	3VA2125-6JP36-0AA0	1 020,—	B	3VA2125-7JP36-0AA0	1 120,—	B	3VA2125-8JP36-0AA0	1 200,—
40	B	3VA2140-6JP36-0AA0	1 020,—	B	3VA2140-7JP36-0AA0	1 120,—	B	3VA2140-8JP36-0AA0	1 200,—
63	B	3VA2163-6JP36-0AA0	1 020,—	B	3VA2163-7JP36-0AA0	1 120,—	B	3VA2163-8JP36-0AA0	1 200,—
100	B	3VA2110-6JP36-0AA0	1 070,—	B	3VA2110-7JP36-0AA0	1 170,—	B	3VA2110-8JP36-0AA0	1 270,—
160	B	3VA2116-6JP36-0AA0	1 370,—	B	3VA2116-7JP36-0AA0	1 510,—	B	3VA2116-8JP36-0AA0	1 650,—

Anschluss Schraubenflanschanschluss

25	B	3VA2025-6JP32-0AA0	991,—	B	3VA2025-7JP32-0AA0	1 090,—	B	3VA2025-8JP32-0AA0	1 180,—
40	B	3VA2040-6JP32-0AA0	991,—	B	3VA2040-7JP32-0AA0	1 090,—	B	3VA2040-8JP32-0AA0	1 180,—
63	B	3VA2063-6JP32-0AA0	991,—	B	3VA2063-7JP32-0AA0	1 090,—	B	3VA2063-8JP32-0AA0	1 180,—
100	B	3VA2010-6JP32-0AA0	1 040,—	B	3VA2010-7JP32-0AA0	1 150,—	B	3VA2010-8JP32-0AA0	1 250,—
25	B	3VA2125-6JP32-0AA0	991,—	B	3VA2125-7JP32-0AA0	1 090,—	B	3VA2125-8JP32-0AA0	1 180,—
40	B	3VA2140-6JP32-0AA0	991,—	B	3VA2140-7JP32-0AA0	1 090,—	B	3VA2140-8JP32-0AA0	1 180,—
63	B	3VA2163-6JP32-0AA0	991,—	B	3VA2163-7JP32-0AA0	1 090,—	B	3VA2163-8JP32-0AA0	1 180,—
100	B	3VA2110-6JP32-0AA0	1 040,—	B	3VA2110-7JP32-0AA0	1 150,—	B	3VA2110-8JP32-0AA0	1 250,—
160	B	3VA2116-6JP32-0AA0	1 340,—	B	3VA2116-7JP32-0AA0	1 480,—	B	3VA2116-8JP32-0AA0	1 630,—
160	B	3VA2216-6JP32-0AA0	1 660,—	B	3VA2216-7JP32-0AA0	1 790,—	B	3VA2216-8JP32-0AA0	1 970,—
250	B	3VA2225-6JP32-0AA0	1 660,—	B	3VA2225-7JP32-0AA0	1 790,—	B	3VA2225-8JP32-0AA0	1 970,—
250	B	3VA2325-6JP32-0AA0	2 020,—	B	3VA2325-7JP32-0AA0	2 180,—	¹⁾ B	3VA2325-8JP32-0AA0	2 430,—
400	B	3VA2340-6JP32-0AA0	2 150,—	B	3VA2340-7JP32-0AA0	2 300,—	¹⁾ B	3VA2340-8JP32-0AA0	2 590,—
400	B	3VA2440-6JP32-0AA0	2 560,—	B	3VA2440-7JP32-0AA0	2 740,—	¹⁾ B	3VA2440-8JP32-0AA0	3 030,—
500	B	3VA2450-6JP32-0AA0	2 560,—	B	3VA2450-7JP32-0AA0	2 740,—			
630	B	3VA2463-6JP32-0AA0	2 750,—	B	3VA2463-7JP32-0AA0	2 940,—	¹⁾ B	3VA2463-8JP32-0AA0	3 250,—

Anlagen- und Generatorschutz, mit Anzeige, ETU560 LSIGMit einstellbarem Überlastauslöser I_r , einstellbarem verzögerten Kurzschlussauslöser I_{sd} , einstellbarem unverzögerten Kurzschlussauslöser I_i und einstellbarem Erdschlussauslöser I_g **Anschluss Rahmenklemme**

25	B	3VA2025-6JQ36-0AA0	1 270,—	B	3VA2025-7JQ36-0AA0	1 380,—	B	3VA2025-8JQ36-0AA0	1 460,—
40	B	3VA2040-6JQ36-0AA0	1 270,—	B	3VA2040-7JQ36-0AA0	1 380,—	B	3VA2040-8JQ36-0AA0	1 460,—
63	B	3VA2063-6JQ36-0AA0	1 270,—	B	3VA2063-7JQ36-0AA0	1 380,—	B	3VA2063-8JQ36-0AA0	1 460,—
100	B	3VA2010-6JQ36-0AA0	1 320,—	B	3VA2010-7JQ36-0AA0	1 430,—	B	3VA2010-8JQ36-0AA0	1 520,—
25	B	3VA2125-6JQ36-0AA0	1 270,—	B	3VA2125-7JQ36-0AA0	1 380,—	B	3VA2125-8JQ36-0AA0	1 460,—
40	B	3VA2140-6JQ36-0AA0	1 270,—	B	3VA2140-7JQ36-0AA0	1 380,—	B	3VA2140-8JQ36-0AA0	1 460,—
63	B	3VA2163-6JQ36-0AA0	1 270,—	B	3VA2163-7JQ36-0AA0	1 380,—	B	3VA2163-8JQ36-0AA0	1 460,—
100	B	3VA2110-6JQ36-0AA0	1 320,—	B	3VA2110-7JQ36-0AA0	1 430,—	B	3VA2110-8JQ36-0AA0	1 520,—
160	B	3VA2116-6JQ36-0AA0	1 620,—	B	3VA2116-7JQ36-0AA0	1 770,—	B	3VA2116-8JQ36-0AA0	1 900,—

Anschluss Schraubenflanschanschluss

25	B	3VA2025-6JQ32-0AA0	1 250,—	B	3VA2025-7JQ32-0AA0	1 350,—	B	3VA2025-8JQ32-0AA0	1 430,—
40	B	3VA2040-6JQ32-0AA0	1 250,—	B	3VA2040-7JQ32-0AA0	1 350,—	B	3VA2040-8JQ32-0AA0	1 430,—
63	B	3VA2063-6JQ32-0AA0	1 250,—	B	3VA2063-7JQ32-0AA0	1 350,—	B	3VA2063-8JQ32-0AA0	1 430,—
100	B	3VA2010-6JQ32-0AA0	1 300,—	B	3VA2010-7JQ32-0AA0	1 410,—	B	3VA2010-8JQ32-0AA0	1 500,—
25	B	3VA2125-6JQ32-0AA0	1 250,—	B	3VA2125-7JQ32-0AA0	1 350,—	B	3VA2125-8JQ32-0AA0	1 430,—
40	B	3VA2140-6JQ32-0AA0	1 250,—	B	3VA2140-7JQ32-0AA0	1 350,—	B	3VA2140-8JQ32-0AA0	1 430,—
63	B	3VA2163-6JQ32-0AA0	1 250,—	B	3VA2163-7JQ32-0AA0	1 350,—	B	3VA2163-8JQ32-0AA0	1 430,—
100	B	3VA2110-6JQ32-0AA0	1 300,—	B	3VA2110-7JQ32-0AA0	1 410,—	B	3VA2110-8JQ32-0AA0	1 500,—
160	B	3VA2116-6JQ32-0AA0	1 590,—	B	3VA2116-7JQ32-0AA0	1 740,—	B	3VA2116-8JQ32-0AA0	1 870,—
160	B	3VA2216-6JQ32-0AA0	1 900,—	B	3VA2216-7JQ32-0AA0	2 050,—	B	3VA2216-8JQ32-0AA0	2 220,—
250	B	3VA2225-6JQ32-0AA0	1 900,—	B	3VA2225-7JQ32-0AA0	2 050,—	B	3VA2225-8JQ32-0AA0	2 220,—
250	B	3VA2325-6JQ32-0AA0	2 270,—	B	3VA2325-7JQ32-0AA0	2 440,—	¹⁾ B	3VA2325-8JQ32-0AA0	2 690,—
400	B	3VA2340-6JQ32-0AA0	2 410,—	B	3VA2340-7JQ32-0AA0	2 560,—	¹⁾ B	3VA2340-8JQ32-0AA0	2 850,—
400	B	3VA2440-6JQ32-0AA0	2 810,—	B	3VA2440-7JQ32-0AA0	2 990,—	¹⁾ B	3VA2440-8JQ32-0AA0	3 280,—
500	B	3VA2450-6JQ32-0AA0	2 810,—	B	3VA2450-7JQ32-0AA0	2 990,—			
630	B	3VA2463-6JQ32-0AA0	2 990,—	B	3VA2463-7JQ32-0AA0	3 200,—	¹⁾ B	3VA2463-8JQ32-0AA0	3 510,—

¹⁾ Liefereinsatz voraussichtlich 3. Quartal 2015

Kompaktleistungsschalter 3VA2 bis 630 A, ETU, 400/690 V, bis 150 kA

Anlagenschutz

PE (ST, SZ, M) = 1

PKG*/VPE = 1 ST

PG = 12P



Anschluss-technik	Typ	Bemessungsstrom I_n	Einstellstrom der stromabhängig verzögerten Überlastauslöser "L" I_r	S-Funktion (kurzzeitverzögerter Kurzschlussauslöser "S") I_{sd}	Ansprechstrom der unverzögerten Kurzschlussauslöser "I" I_i	LK
		A	A	A	A	

I_{cu} bis 55 kA bei 415 V, Mittleres Schaltvermögen M
siehe "Übersicht", S. 1/6 und 1/7

Artikel-Nr. www.siemens.com/product?Artikel-Nr. Grundpreis € pro PE

3-polig, Festeinbau, 3VA20 bis 3VA24, bis 630 A Elektronischer Überstromauslöser



I201_18482

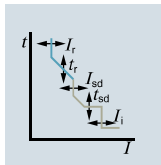

Anlagen- und Generatorschutz, mit Anzeige, mit Messfunktion, ETU850 LSI

Mit einstellbarem Überlastauslöser I_r , einstellbarem verzögerten Kurzschlussauslöser I_{sd} und einstellbarem unverzögerten Kurzschlussauslöser I_i

Anschluss Rahmenklemme

Typ	I_n	I_r	I_{sd}	I_i	LK	Artikel-Nr.	Preis
3VA20	25	10 ... 25	15 ... 250	38 ... 300	B	3VA2025-5KP36-0AA0	1 070,—
	40	16 ... 40	24 ... 400	60 ... 480	B	3VA2040-5KP36-0AA0	1 070,—
	63	25 ... 63	38 ... 630	95 ... 756	B	3VA2063-5KP36-0AA0	1 070,—
	100	40 ... 100	60 ... 1000	150 ... 1200	B	3VA2010-5KP36-0AA0	1 110,—
3VA21	25	10 ... 25	15 ... 250	38 ... 300	B	3VA2125-5KP36-0AA0	1 070,—
	40	16 ... 40	24 ... 400	60 ... 480	B	3VA2140-5KP36-0AA0	1 070,—
	63	25 ... 63	38 ... 630	95 ... 756	B	3VA2163-5KP36-0AA0	1 070,—
	100	40 ... 100	60 ... 1000	150 ... 1200	B	3VA2110-5KP36-0AA0	1 110,—
160	63 ... 160	96 ... 1600	240 ... 1600	B	3VA2116-5KP36-0AA0	1 390,—	

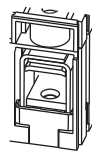

Anschluss Schraubenflachanschluss

Typ	I_n	I_r	I_{sd}	I_i	LK	Artikel-Nr.	Preis
3VA20	25	10 ... 25	15 ... 250	38 ... 300	B	3VA2025-5KP32-0AA0	1 040,—
	40	16 ... 40	24 ... 400	60 ... 480	B	3VA2040-5KP32-0AA0	1 040,—
	63	25 ... 63	38 ... 630	95 ... 756	B	3VA2063-5KP32-0AA0	1 040,—
	100	40 ... 100	60 ... 1000	150 ... 1200	B	3VA2010-5KP32-0AA0	1 080,—
3VA21	25	10 ... 25	15 ... 250	38 ... 300	B	3VA2125-5KP32-0AA0	1 040,—
	40	16 ... 40	24 ... 400	60 ... 480	B	3VA2140-5KP32-0AA0	1 040,—
	63	25 ... 63	38 ... 630	95 ... 756	B	3VA2163-5KP32-0AA0	1 040,—
	100	40 ... 100	60 ... 1000	150 ... 1200	B	3VA2110-5KP32-0AA0	1 080,—
160	63 ... 160	96 ... 1600	240 ... 1600	B	3VA2116-5KP32-0AA0	1 370,—	
3VA22	160	63 ... 160	96 ... 1600	240 ... 1920	B	3VA2216-5KP32-0AA0	1 630,—
	250	100 ... 250	150 ... 2500	375 ... 2500	B	3VA2225-5KP32-0AA0	1 630,—
3VA23	250	100 ... 250	150 ... 2500	375 ... 3000	B	3VA2325-5KP32-0AA0	1 990,—
	400	160 ... 400	240 ... 4000	600 ... 4000	B	3VA2340-5KP32-0AA0	2 090,—
3VA24	400	160 ... 400	240 ... 4000	600 ... 6000 ¹⁾	B	3VA2440-5KP32-0AA0	2 450,—
	500	200 ... 500	300 ... 5000	750 ... 7000	B	3VA2450-5KP32-0AA0	2 450,—
	630	250 ... 630	378 ... 5670	945 ... 5670	B	3VA2463-5KP32-0AA0	2 610,—

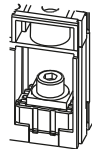

I201_18483

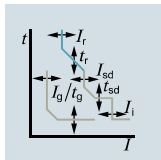

Anlagen- und Generatorschutz, mit Anzeige, mit Messfunktion, ETU860 LSIG

Mit einstellbarem Überlastauslöser I_r , einstellbarem verzögerten Kurzschlussauslöser I_{sd} , einstellbarem unverzögerten Kurzschlussauslöser I_i und einstellbarem Erdschlussauslöser I_G

Anschluss Rahmenklemme

Typ	I_n	I_r	I_{sd}	I_i	LK	Artikel-Nr.	Preis
3VA20	25	10 ... 25	15 ... 250	38 ... 300	B	3VA2025-5KQ36-0AA0	1 320,—
	40	16 ... 40	24 ... 400	60 ... 480	B	3VA2040-5KQ36-0AA0	1 320,—
	63	25 ... 63	38 ... 630	95 ... 756	B	3VA2063-5KQ36-0AA0	1 320,—
	100	40 ... 100	60 ... 1000	150 ... 1200	B	3VA2010-5KQ36-0AA0	1 390,—
3VA21	25	10 ... 25	15 ... 250	38 ... 300	B	3VA2125-5KQ36-0AA0	1 320,—
	40	16 ... 40	24 ... 400	60 ... 480	B	3VA2140-5KQ36-0AA0	1 320,—
	63	25 ... 63	38 ... 630	95 ... 756	B	3VA2163-5KQ36-0AA0	1 320,—
	100	40 ... 100	60 ... 1000	150 ... 1200	B	3VA2110-5KQ36-0AA0	1 390,—
160	63 ... 160	96 ... 1600	240 ... 1600	B	3VA2116-5KQ36-0AA0	1 660,—	

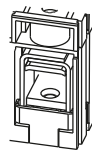

Anschluss Schraubenflachanschluss

Typ	I_n	I_r	I_{sd}	I_i	LK	Artikel-Nr.	Preis
3VA20	25	10 ... 25	15 ... 250	38 ... 300	B	3VA2025-5KQ32-0AA0	1 300,—
	40	16 ... 40	24 ... 400	60 ... 480	B	3VA2040-5KQ32-0AA0	1 300,—
	63	25 ... 63	38 ... 630	95 ... 756	B	3VA2063-5KQ32-0AA0	1 300,—
	100	40 ... 100	60 ... 1000	150 ... 1200	B	3VA2010-5KQ32-0AA0	1 340,—
3VA21	25	10 ... 25	15 ... 250	38 ... 300	B	3VA2125-5KQ32-0AA0	1 300,—
	40	16 ... 40	24 ... 400	60 ... 480	B	3VA2140-5KQ32-0AA0	1 300,—
	63	25 ... 63	38 ... 630	95 ... 756	B	3VA2163-5KQ32-0AA0	1 300,—
	100	40 ... 100	60 ... 1000	150 ... 1200	B	3VA2110-5KQ32-0AA0	1 340,—
160	63 ... 160	96 ... 1600	240 ... 1600	B	3VA2116-5KQ32-0AA0	1 630,—	
3VA22	160	63 ... 160	96 ... 1600	240 ... 1920	B	3VA2216-5KQ32-0AA0	1 870,—
	250	100 ... 250	150 ... 2500	375 ... 2500	B	3VA2225-5KQ32-0AA0	1 870,—
3VA23	250	100 ... 250	150 ... 2500	375 ... 3000	B	3VA2325-5KQ32-0AA0	2 240,—
	400	160 ... 400	240 ... 4000	600 ... 4000	B	3VA2340-5KQ32-0AA0	2 370,—
3VA24	400	160 ... 400	240 ... 4000	600 ... 6000 ¹⁾	B	3VA2440-5KQ32-0AA0	2 730,—
	500	200 ... 500	300 ... 5000	750 ... 7000	B	3VA2450-5KQ32-0AA0	2 730,—
	630	250 ... 630	378 ... 5670	945 ... 5670	B	3VA2463-5KQ32-0AA0	2 870,—

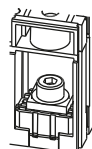

¹⁾ bei Schaltvermögen L 4400 A

Kompaktleistungsschalter 3VA2 bis 630 A, ETU, 400/690 V, bis 150 kA

Anlagenschutz

PE (ST, SZ, M) = 1

PKG*/VPE = 1 ST

PG = 12P

Bemes- sungs- strom I_n	LK	I_{cu} bis 85 kA bei 415 V, Hohes Schaltvermögen H siehe "Übersicht", S. 1/6 und 1/7	(H)	LK	I_{cu} bis 110 kA bei 415 V, Sehr hohes Schaltvermögen C siehe "Übersicht", S. 1/6 und 1/7	(C)	LK	I_{cu} bis 150 kA bei 415 V, Extrem hohes Schaltvermögen L siehe "Übersicht", S. 1/6 und 1/7	(L)
		Artikel-Nr. www.siemens.com/ product?Artikel-Nr.	Grund- preis € pro PE		Artikel-Nr. www.siemens.com/ product?Artikel-Nr.	Grund- preis € pro PE		Artikel-Nr. www.siemens.com/ product?Artikel-Nr.	Grund- preis € pro PE
A									

Anlagen- und Generatorschutz, mit Anzeige, mit Messfunktion, ETU850 LSIMit einstellbarem Überlastauslöser I_T , einstellbarem verzögerten Kurzschlussauslöser I_{sd} und einstellbarem unverzögerten Kurzschlussauslöser I_i **Anschluss Rahmenklemme**

25	B	3VA2025-6KP36-0AA0	1 120,—	B	3VA2025-7KP36-0AA0	1 220,—	B	3VA2025-8KP36-0AA0	1 310,—
40	B	3VA2040-6KP36-0AA0	1 120,—	B	3VA2040-7KP36-0AA0	1 220,—	B	3VA2040-8KP36-0AA0	1 310,—
63	B	3VA2063-6KP36-0AA0	1 120,—	B	3VA2063-7KP36-0AA0	1 220,—	B	3VA2063-8KP36-0AA0	1 310,—
100	B	3VA2010-6KP36-0AA0	1 170,—	B	3VA2010-7KP36-0AA0	1 280,—	B	3VA2010-8KP36-0AA0	1 370,—
25	B	3VA2125-6KP36-0AA0	1 120,—	B	3VA2125-7KP36-0AA0	1 220,—	B	3VA2125-8KP36-0AA0	1 310,—
40	B	3VA2140-6KP36-0AA0	1 120,—	B	3VA2140-7KP36-0AA0	1 220,—	B	3VA2140-8KP36-0AA0	1 310,—
63	B	3VA2163-6KP36-0AA0	1 120,—	B	3VA2163-7KP36-0AA0	1 220,—	B	3VA2163-8KP36-0AA0	1 310,—
100	B	3VA2110-6KP36-0AA0	1 170,—	B	3VA2110-7KP36-0AA0	1 280,—	B	3VA2110-8KP36-0AA0	1 370,—
160	B	3VA2116-6KP36-0AA0	1 470,—	B	3VA2116-7KP36-0AA0	1 620,—	B	3VA2116-8KP36-0AA0	1 750,—

Anschluss Schraubenflanschanschluss

25	B	3VA2025-6KP32-0AA0	1 090,—	B	3VA2025-7KP32-0AA0	1 190,—	B	3VA2025-8KP32-0AA0	1 290,—
40	B	3VA2040-6KP32-0AA0	1 090,—	B	3VA2040-7KP32-0AA0	1 190,—	B	3VA2040-8KP32-0AA0	1 290,—
63	B	3VA2063-6KP32-0AA0	1 090,—	B	3VA2063-7KP32-0AA0	1 190,—	B	3VA2063-8KP32-0AA0	1 290,—
100	B	3VA2010-6KP32-0AA0	1 140,—	B	3VA2010-7KP32-0AA0	1 260,—	B	3VA2010-8KP32-0AA0	1 350,—
25	B	3VA2125-6KP32-0AA0	1 090,—	B	3VA2125-7KP32-0AA0	1 190,—	B	3VA2125-8KP32-0AA0	1 290,—
40	B	3VA2140-6KP32-0AA0	1 090,—	B	3VA2140-7KP32-0AA0	1 190,—	B	3VA2140-8KP32-0AA0	1 290,—
63	B	3VA2163-6KP32-0AA0	1 090,—	B	3VA2163-7KP32-0AA0	1 190,—	B	3VA2163-8KP32-0AA0	1 290,—
100	B	3VA2110-6KP32-0AA0	1 140,—	B	3VA2110-7KP32-0AA0	1 260,—	B	3VA2110-8KP32-0AA0	1 350,—
160	B	3VA2116-6KP32-0AA0	1 440,—	B	3VA2116-7KP32-0AA0	1 580,—	B	3VA2116-8KP32-0AA0	1 730,—
160	B	3VA2216-6KP32-0AA0	1 780,—	B	3VA2216-7KP32-0AA0	1 890,—	B	3VA2216-8KP32-0AA0	2 070,—
250	B	3VA2225-6KP32-0AA0	1 780,—	B	3VA2225-7KP32-0AA0	1 890,—	B	3VA2225-8KP32-0AA0	2 070,—
250	B	3VA2325-6KP32-0AA0	2 120,—	B	3VA2325-7KP32-0AA0	2 260,—	¹⁾ B	3VA2325-8KP32-0AA0	2 520,—
400	B	3VA2340-6KP32-0AA0	2 270,—	B	3VA2340-7KP32-0AA0	2 400,—	¹⁾ B	3VA2340-8KP32-0AA0	2 700,—
400	B	3VA2440-6KP32-0AA0	2 670,—	B	3VA2440-7KP32-0AA0	2 840,—	¹⁾ B	3VA2440-8KP32-0AA0	3 130,—
500	B	3VA2450-6KP32-0AA0	2 670,—	B	3VA2450-7KP32-0AA0	2 840,—		---	
630	B	3VA2463-6KP32-0AA0	2 830,—	B	3VA2463-7KP32-0AA0	3 050,—	¹⁾ B	3VA2463-8KP32-0AA0	3 340,—

Anlagen- und Generatorschutz, mit Anzeige, mit Messfunktion, ETU860 LSIgMit einstellbarem Überlastauslöser I_T , einstellbarem verzögerten Kurzschlussauslöser I_{sd} , einstellbarem unverzögerten Kurzschlussauslöser I_i und einstellbarem Erdschlussauslöser I_g **Anschluss Rahmenklemme**

25	B	3VA2025-6KQ36-0AA0	1 380,—	B	3VA2025-7KQ36-0AA0	1 480,—	B	3VA2025-8KQ36-0AA0	1 560,—
40	B	3VA2040-6KQ36-0AA0	1 380,—	B	3VA2040-7KQ36-0AA0	1 480,—	B	3VA2040-8KQ36-0AA0	1 560,—
63	B	3VA2063-6KQ36-0AA0	1 380,—	B	3VA2063-7KQ36-0AA0	1 480,—	B	3VA2063-8KQ36-0AA0	1 560,—
100	B	3VA2010-6KQ36-0AA0	1 420,—	B	3VA2010-7KQ36-0AA0	1 530,—	B	3VA2010-8KQ36-0AA0	1 630,—
25	B	3VA2125-6KQ36-0AA0	1 380,—	B	3VA2125-7KQ36-0AA0	1 480,—	B	3VA2125-8KQ36-0AA0	1 560,—
40	B	3VA2140-6KQ36-0AA0	1 380,—	B	3VA2140-7KQ36-0AA0	1 480,—	B	3VA2140-8KQ36-0AA0	1 560,—
63	B	3VA2163-6KQ36-0AA0	1 380,—	B	3VA2163-7KQ36-0AA0	1 480,—	B	3VA2163-8KQ36-0AA0	1 560,—
100	B	3VA2110-6KQ36-0AA0	1 420,—	B	3VA2110-7KQ36-0AA0	1 530,—	B	3VA2110-8KQ36-0AA0	1 630,—
160	B	3VA2116-6KQ36-0AA0	1 720,—	B	3VA2116-7KQ36-0AA0	1 870,—	B	3VA2116-8KQ36-0AA0	2 010,—

Anschluss Schraubenflanschanschluss

25	B	3VA2025-6KQ32-0AA0	1 350,—	B	3VA2025-7KQ32-0AA0	1 450,—	B	3VA2025-8KQ32-0AA0	1 530,—
40	B	3VA2040-6KQ32-0AA0	1 350,—	B	3VA2040-7KQ32-0AA0	1 450,—	B	3VA2040-8KQ32-0AA0	1 530,—
63	B	3VA2063-6KQ32-0AA0	1 350,—	B	3VA2063-7KQ32-0AA0	1 450,—	B	3VA2063-8KQ32-0AA0	1 530,—
100	B	3VA2010-6KQ32-0AA0	1 400,—	B	3VA2010-7KQ32-0AA0	1 510,—	B	3VA2010-8KQ32-0AA0	1 610,—
25	B	3VA2125-6KQ32-0AA0	1 350,—	B	3VA2125-7KQ32-0AA0	1 450,—	B	3VA2125-8KQ32-0AA0	1 530,—
40	B	3VA2140-6KQ32-0AA0	1 350,—	B	3VA2140-7KQ32-0AA0	1 450,—	B	3VA2140-8KQ32-0AA0	1 530,—
63	B	3VA2163-6KQ32-0AA0	1 350,—	B	3VA2163-7KQ32-0AA0	1 450,—	B	3VA2163-8KQ32-0AA0	1 530,—
100	B	3VA2110-6KQ32-0AA0	1 400,—	B	3VA2110-7KQ32-0AA0	1 510,—	B	3VA2110-8KQ32-0AA0	1 610,—
160	B	3VA2116-6KQ32-0AA0	1 700,—	B	3VA2116-7KQ32-0AA0	1 840,—	B	3VA2116-8KQ32-0AA0	1 980,—
160	B	3VA2216-6KQ32-0AA0	2 020,—	B	3VA2216-7KQ32-0AA0	2 150,—	B	3VA2216-8KQ32-0AA0	2 330,—
250	B	3VA2225-6KQ32-0AA0	2 020,—	B	3VA2225-7KQ32-0AA0	2 150,—	B	3VA2225-8KQ32-0AA0	2 330,—
250	B	3VA2325-6KQ32-0AA0	2 380,—	B	3VA2325-7KQ32-0AA0	2 540,—	¹⁾ B	3VA2325-8KQ32-0AA0	2 790,—
400	B	3VA2340-6KQ32-0AA0	2 510,—	B	3VA2340-7KQ32-0AA0	2 670,—	¹⁾ B	3VA2340-8KQ32-0AA0	2 950,—
400	B	3VA2440-6KQ32-0AA0	2 910,—	B	3VA2440-7KQ32-0AA0	3 100,—	¹⁾ B	3VA2440-8KQ32-0AA0	3 390,—
500	B	3VA2450-6KQ32-0AA0	2 910,—	B	3VA2450-7KQ32-0AA0	3 100,—		---	
630	B	3VA2463-6KQ32-0AA0	3 100,—	B	3VA2463-7KQ32-0AA0	3 300,—	¹⁾ B	3VA2463-8KQ32-0AA0	3 610,—

¹⁾ Liefereinsatz voraussichtlich 3. Quartal 2015* Diese Menge oder ein Vielfaches dieser Menge kann bestellt werden.
Unverbindliche Preisempfehlungen, ggf. zuzüglich Metallzuschläge (MZ)

Kompaktleistungsschalter 3VA2 bis 630 A, ETU, 400/690 V, bis 150 kA

Anlagenschutz

PE (ST, SZ, M) = 1

PKG*/VPE = 1 ST

PG = 12P



Anschluss- technik	Typ	Bemes- sungs- strom I_n	Einstellstrom der strom- abhängig verzögerten Überlast- auslöser "L" I_r	S-Funktion (kurzzeit- verzöger- ter Kurz- schluss- schutz "S") I_{sd}	Ansprech- strom der un- verzögerten Kurzschluss- auslöser "I" I_i	LK
		A	A	A	A	

I_{cu} bis 55 kA bei 415 V,
Mittleres Schaltvermögen M
siehe "Übersicht", S. 1/6 und 1/7

Artikel-Nr.
[www.siemens.com/
product?Artikel-Nr.](http://www.siemens.com/product?Artikel-Nr.)

Grund-
preis €
pro PE

4-polig, Festeinbau, 3VA20 bis 3VA24, bis 630 A Elektronischer Überstromauslöser



I201_18830

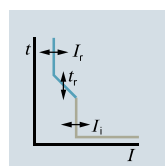

Anlagenschutz, ETU320 LI

Mit einstellbarem Überlastauslöser I_r und einstellbarem unverzögerten Kurzschlussauslöser I_i , mit "N"-Überlast- und Kurzschlussauslöser 0 %, 50 % oder 100 %

Anschluss Rahmenklemme

3VA20	25	40	63	100	10 ... 25	16 ... 40	25 ... 63	40 ... 100	--	38 ... 300	60 ... 480	95 ... 756	150 ... 1200	B	3VA2025-5HL46-0AA0	646,—
	40	63	100	25	40	63	100	160	--	38 ... 300	60 ... 480	95 ... 756	150 ... 1200	B	3VA2040-5HL46-0AA0	646,—
	40	63	100	25	40	63	100	160	--	38 ... 300	60 ... 480	95 ... 756	150 ... 1200	B	3VA2063-5HL46-0AA0	646,—
	40	63	100	25	40	63	100	160	--	38 ... 300	60 ... 480	95 ... 756	150 ... 1200	B	3VA2010-5HL46-0AA0	709,—
3VA21	25	40	63	100	160	10 ... 25	16 ... 40	25 ... 63	40 ... 100	38 ... 300	60 ... 480	95 ... 756	150 ... 1200	B	3VA2125-5HL46-0AA0	646,—
	40	63	100	160	25	40	63	100	160	38 ... 300	60 ... 480	95 ... 756	150 ... 1200	B	3VA2140-5HL46-0AA0	646,—
	40	63	100	160	25	40	63	100	160	38 ... 300	60 ... 480	95 ... 756	150 ... 1200	B	3VA2163-5HL46-0AA0	646,—
	40	63	100	160	25	40	63	100	160	38 ... 300	60 ... 480	95 ... 756	150 ... 1200	B	3VA2110-5HL46-0AA0	709,—
	40	63	100	160	25	40	63	100	160	38 ... 300	60 ... 480	95 ... 756	150 ... 1200	B	3VA2116-5HL46-0AA0	1 050,—

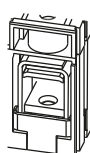

Anschluss Schraubenflachanschluss

3VA20	25	40	63	100	10 ... 25	16 ... 40	25 ... 63	40 ... 100	--	38 ... 300	60 ... 480	95 ... 756	150 ... 1200	B	3VA2025-5HL42-0AA0	623,—
	40	63	100	25	40	63	100	160	-- <td>38 ... 300 <td>60 ... 480 <td>95 ... 756 <td>150 ... 1200 <td>B <td>3VA2040-5HL42-0AA0 <td>623,—</td> </td></td></td></td></td></td>	38 ... 300 <td>60 ... 480 <td>95 ... 756 <td>150 ... 1200 <td>B <td>3VA2040-5HL42-0AA0 <td>623,—</td> </td></td></td></td></td>	60 ... 480 <td>95 ... 756 <td>150 ... 1200 <td>B <td>3VA2040-5HL42-0AA0 <td>623,—</td> </td></td></td></td>	95 ... 756 <td>150 ... 1200 <td>B <td>3VA2040-5HL42-0AA0 <td>623,—</td> </td></td></td>	150 ... 1200 <td>B <td>3VA2040-5HL42-0AA0 <td>623,—</td> </td></td>	B <td>3VA2040-5HL42-0AA0 <td>623,—</td> </td>	3VA2040-5HL42-0AA0 <td>623,—</td>	623,—
	40	63	100	25	40	63	100	160	-- <td>38 ... 300 <td>60 ... 480 <td>95 ... 756 <td>150 ... 1200 <td>B <td>3VA2063-5HL42-0AA0 <td>623,—</td> </td></td></td></td></td></td>	38 ... 300 <td>60 ... 480 <td>95 ... 756 <td>150 ... 1200 <td>B <td>3VA2063-5HL42-0AA0 <td>623,—</td> </td></td></td></td></td>	60 ... 480 <td>95 ... 756 <td>150 ... 1200 <td>B <td>3VA2063-5HL42-0AA0 <td>623,—</td> </td></td></td></td>	95 ... 756 <td>150 ... 1200 <td>B <td>3VA2063-5HL42-0AA0 <td>623,—</td> </td></td></td>	150 ... 1200 <td>B <td>3VA2063-5HL42-0AA0 <td>623,—</td> </td></td>	B <td>3VA2063-5HL42-0AA0 <td>623,—</td> </td>	3VA2063-5HL42-0AA0 <td>623,—</td>	623,—
	40	63	100	25	40	63	100	160	-- <td>38 ... 300 <td>60 ... 480 <td>95 ... 756 <td>150 ... 1200 <td>B <td>3VA2010-5HL42-0AA0 <td>676,—</td> </td></td></td></td></td></td>	38 ... 300 <td>60 ... 480 <td>95 ... 756 <td>150 ... 1200 <td>B <td>3VA2010-5HL42-0AA0 <td>676,—</td> </td></td></td></td></td>	60 ... 480 <td>95 ... 756 <td>150 ... 1200 <td>B <td>3VA2010-5HL42-0AA0 <td>676,—</td> </td></td></td></td>	95 ... 756 <td>150 ... 1200 <td>B <td>3VA2010-5HL42-0AA0 <td>676,—</td> </td></td></td>	150 ... 1200 <td>B <td>3VA2010-5HL42-0AA0 <td>676,—</td> </td></td>	B <td>3VA2010-5HL42-0AA0 <td>676,—</td> </td>	3VA2010-5HL42-0AA0 <td>676,—</td>	676,—
3VA21	25	40	63	100	160	10 ... 25	16 ... 40	25 ... 63	40 ... 100	38 ... 300 <td>60 ... 480 <td>95 ... 756 <td>150 ... 1200 <td>B</td> <td>3VA2125-5HL42-0AA0</td> <td>623,—</td> </td></td></td>	60 ... 480 <td>95 ... 756 <td>150 ... 1200 <td>B</td> <td>3VA2125-5HL42-0AA0</td> <td>623,—</td> </td></td>	95 ... 756 <td>150 ... 1200 <td>B</td> <td>3VA2125-5HL42-0AA0</td> <td>623,—</td> </td>	150 ... 1200 <td>B</td> <td>3VA2125-5HL42-0AA0</td> <td>623,—</td>	B	3VA2125-5HL42-0AA0	623,—
	40	63	100	160	25	40	63	100	160	38 ... 300 <td>60 ... 480 <td>95 ... 756 <td>150 ... 1200 <td>B</td> <td>3VA2140-5HL42-0AA0</td> <td>623,—</td> </td></td></td>	60 ... 480 <td>95 ... 756 <td>150 ... 1200 <td>B</td> <td>3VA2140-5HL42-0AA0</td> <td>623,—</td> </td></td>	95 ... 756 <td>150 ... 1200 <td>B</td> <td>3VA2140-5HL42-0AA0</td> <td>623,—</td> </td>	150 ... 1200 <td>B</td> <td>3VA2140-5HL42-0AA0</td> <td>623,—</td>	B	3VA2140-5HL42-0AA0	623,—
	40	63	100	160	25	40	63	100	160	38 ... 300 <td>60 ... 480 <td>95 ... 756 <td>150 ... 1200 <td>B</td> <td>3VA2163-5HL42-0AA0</td> <td>623,—</td> </td></td></td>	60 ... 480 <td>95 ... 756 <td>150 ... 1200 <td>B</td> <td>3VA2163-5HL42-0AA0</td> <td>623,—</td> </td></td>	95 ... 756 <td>150 ... 1200 <td>B</td> <td>3VA2163-5HL42-0AA0</td> <td>623,—</td> </td>	150 ... 1200 <td>B</td> <td>3VA2163-5HL42-0AA0</td> <td>623,—</td>	B	3VA2163-5HL42-0AA0	623,—
	40	63	100	160	25	40	63	100	160	38 ... 300 <td>60 ... 480 <td>95 ... 756 <td>150 ... 1200 <td>B</td> <td>3VA2110-5HL42-0AA0</td> <td>676,—</td> </td></td></td>	60 ... 480 <td>95 ... 756 <td>150 ... 1200 <td>B</td> <td>3VA2110-5HL42-0AA0</td> <td>676,—</td> </td></td>	95 ... 756 <td>150 ... 1200 <td>B</td> <td>3VA2110-5HL42-0AA0</td> <td>676,—</td> </td>	150 ... 1200 <td>B</td> <td>3VA2110-5HL42-0AA0</td> <td>676,—</td>	B	3VA2110-5HL42-0AA0	676,—
	40	63	100	160	25	40	63	100	160	38 ... 300 <td>60 ... 480 <td>95 ... 756 <td>150 ... 1200 <td>B</td> <td>3VA2116-5HL42-0AA0</td> <td>1 020,—</td> </td></td></td>	60 ... 480 <td>95 ... 756 <td>150 ... 1200 <td>B</td> <td>3VA2116-5HL42-0AA0</td> <td>1 020,—</td> </td></td>	95 ... 756 <td>150 ... 1200 <td>B</td> <td>3VA2116-5HL42-0AA0</td> <td>1 020,—</td> </td>	150 ... 1200 <td>B</td> <td>3VA2116-5HL42-0AA0</td> <td>1 020,—</td>	B	3VA2116-5HL42-0AA0	1 020,—
3VA22	160	250	100 ... 250	63 ... 160	250	63 ... 160	100 ... 250	--	--	240 ... 1920	375 ... 2500	375 ... 2500	600 ... 4000	B	3VA2216-5HL42-0AA0	1 360,—
	250	100 ... 250	63 ... 160	250	63 ... 160	100 ... 250	--	--	--	240 ... 1920	375 ... 2500	375 ... 2500	600 ... 4000	B	3VA2225-5HL42-0AA0	1 360,—
3VA23	250	400	100 ... 250	160 ... 400	400	100 ... 250	160 ... 400	--	--	375 ... 3000	600 ... 4000	600 ... 4000	--	B	3VA2325-5HL42-0AA0	1 750,—
	400	100 ... 250	160 ... 400	400	100 ... 250	160 ... 400	--	--	--	375 ... 3000	600 ... 4000	600 ... 4000	--	B	3VA2340-5HL42-0AA0	1 900,—
3VA24	400	630	160 ... 400	250 ... 630	630	160 ... 400	250 ... 630	--	--	600 ... 4800 ¹⁾	945 ... 5670	945 ... 5670	--	B	3VA2440-5HL42-0AA0	2 340,—
	630	160 ... 400	250 ... 630	630	160 ... 400	250 ... 630	--	--	--	600 ... 4800 ¹⁾	945 ... 5670	945 ... 5670	--	B	3VA2463-5HL42-0AA0	2 530,—

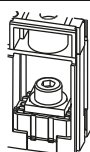

¹⁾ bei Schaltvermögen L 4400 A

Kompaktleistungsschalter 3VA2 bis 630 A, ETU, 400/690 V, bis 150 kA

Anlagenschutz

PE (ST, SZ, M) = 1

PKG*/VPE = 1 ST

PG = 12P

Bemes- sungs- strom I_n	LK	I_{cu} bis 85 kA bei 415 V, Hohes Schaltvermögen H siehe "Übersicht", S. 1/6 und 1/7	(H)	LK	I_{cu} bis 110 kA bei 415 V, Sehr hohes Schaltvermögen C siehe "Übersicht", S. 1/6 und 1/7	(C)	LK	I_{cu} bis 150 kA bei 415 V, Extrem hohes Schaltvermögen L siehe "Übersicht", S. 1/6 und 1/7	(L)
A		Artikel-Nr. www.siemens.com/ product?Artikel-Nr.	Grund- preis € pro PE		Artikel-Nr. www.siemens.com/ product?Artikel-Nr.	Grund- preis € pro PE		Artikel-Nr. www.siemens.com/ product?Artikel-Nr.	Grund- preis € pro PE

Anlagenschutz, ETU320 LI

Mit einstellbarem Überlastauslöser I_T und einstellbarem unverzögerten Kurzschlussauslöser I_{sc} mit "N"-Überlast- und Kurzschlussauslöser 0 %, 50 % oder 100 %

Anschluss Rahmenklemme

25	B	3VA2025-6HL46-0AA0	719,—	B	3VA2025-7HL46-0AA0	846,—	B	3VA2025-8HL46-0AA0	949,—
40	B	3VA2040-6HL46-0AA0	719,—	B	3VA2040-7HL46-0AA0	846,—	B	3VA2040-8HL46-0AA0	949,—
63	B	3VA2063-6HL46-0AA0	719,—	B	3VA2063-7HL46-0AA0	846,—	B	3VA2063-8HL46-0AA0	949,—
100	B	3VA2010-6HL46-0AA0	779,—	B	3VA2010-7HL46-0AA0	917,—	B	3VA2010-8HL46-0AA0	1 030,—
25	B	3VA2125-6HL46-0AA0	719,—	B	3VA2125-7HL46-0AA0	846,—	B	3VA2125-8HL46-0AA0	949,—
40	B	3VA2140-6HL46-0AA0	719,—	B	3VA2140-7HL46-0AA0	846,—	B	3VA2140-8HL46-0AA0	949,—
63	B	3VA2163-6HL46-0AA0	719,—	B	3VA2163-7HL46-0AA0	846,—	B	3VA2163-8HL46-0AA0	949,—
100	B	3VA2110-6HL46-0AA0	779,—	B	3VA2110-7HL46-0AA0	917,—	B	3VA2110-8HL46-0AA0	1 030,—
160	B	3VA2116-6HL46-0AA0	1 140,—	B	3VA2116-7HL46-0AA0	1 320,—	B	3VA2116-8HL46-0AA0	1 460,—

Anschluss Schraubenflachanschluss

25	B	3VA2025-6HL42-0AA0	686,—	B	3VA2025-7HL42-0AA0	813,—	B	3VA2025-8HL42-0AA0	916,—
40	B	3VA2040-6HL42-0AA0	686,—	B	3VA2040-7HL42-0AA0	813,—	B	3VA2040-8HL42-0AA0	916,—
63	B	3VA2063-6HL42-0AA0	686,—	B	3VA2063-7HL42-0AA0	813,—	B	3VA2063-8HL42-0AA0	916,—
100	B	3VA2010-6HL42-0AA0	746,—	B	3VA2010-7HL42-0AA0	884,—	B	3VA2010-8HL42-0AA0	996,—
25	B	3VA2125-6HL42-0AA0	686,—	B	3VA2125-7HL42-0AA0	813,—	B	3VA2125-8HL42-0AA0	916,—
40	B	3VA2140-6HL42-0AA0	686,—	B	3VA2140-7HL42-0AA0	813,—	B	3VA2140-8HL42-0AA0	916,—
63	B	3VA2163-6HL42-0AA0	686,—	B	3VA2163-7HL42-0AA0	813,—	B	3VA2163-8HL42-0AA0	916,—
100	B	3VA2110-6HL42-0AA0	746,—	B	3VA2110-7HL42-0AA0	884,—	B	3VA2110-8HL42-0AA0	996,—
160	B	3VA2116-6HL42-0AA0	1 110,—	B	3VA2116-7HL42-0AA0	1 290,—	B	3VA2116-8HL42-0AA0	1 450,—
160	B	3VA2216-6HL42-0AA0	1 530,—	B	3VA2216-7HL42-0AA0	1 670,—	B	3VA2216-8HL42-0AA0	1 870,—
250	B	3VA2225-6HL42-0AA0	1 530,—	B	3VA2225-7HL42-0AA0	1 670,—	B	3VA2225-8HL42-0AA0	1 870,—
250	B	3VA2325-6HL42-0AA0	1 910,—	B	3VA2325-7HL42-0AA0	2 100,—	¹⁾ B	3VA2325-8HL42-0AA0	2 520,—
400	B	3VA2340-6HL42-0AA0	2 080,—	B	3VA2340-7HL42-0AA0	2 280,—	¹⁾ B	3VA2340-8HL42-0AA0	2 730,—
400	B	3VA2440-6HL42-0AA0	2 590,—	B	3VA2440-7HL42-0AA0	2 900,—	¹⁾ B	3VA2440-8HL42-0AA0	3 240,—
630	B	3VA2463-6HL42-0AA0	2 780,—	B	3VA2463-7HL42-0AA0	3 150,—	¹⁾ B	3VA2463-8HL42-0AA0	3 470,—

¹⁾ Liefereinsatz voraussichtlich 3. Quartal 2015

Kompaktleistungsschalter 3VA2 bis 630 A, ETU, 400/690 V, bis 150 kA

Anlagenschutz

PE (ST, SZ, M) = 1

PKG*/VPE = 1 ST

PG = 12P



Anschluss-technik	Typ	Bemes-sungs-strom I_n	Einstellstrom der strom-abhängig verzögerten Überlast-auslöser "L" I_r	Ansprech-strom der un-verzögerten Kurzschluss-auslöser "I" I_i	Erd-schluss-schutz I_g	LK
		A	A	A	A	

I_{cu} bis 55 kA bei 415 V, Mittleres Schaltvermögen M (M)
siehe "Übersicht", S. 1/6 und 1/7

Artikel-Nr. www.siemens.com/product?Artikel-Nr. Grundpreis € pro PE

4-polig, Festeinbau, 3VA20 bis 3VA24, bis 630 A Elektronischer Überstromauslöser



1201_18829

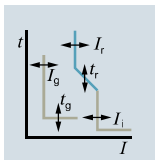

Anlagenschutz, ETU330 LIG

Mit einstellbarem Überlastauslöser I_r , einstellbarem unverzögerten Kurzschlussauslöser I_i , mit "N"-Überlast- und Kurzschlussauslöser 0 %, 50 % oder 100 % und einstellbarem Erdschlussauslöser I_g

Anschluss Rahmenklemme

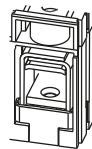

3VA20	25	10 ... 25	38 ... 300	15 ... 25	B	3VA2025-5HM46-0AA0	900,—
	40	16 ... 40	60 ... 480	16 ... 40	B	3VA2040-5HM46-0AA0	900,—
	63	25 ... 63	95 ... 756	16 ... 63	B	3VA2063-5HM46-0AA0	900,—
	100	40 ... 100	150 ... 1200	20 ... 100	B	3VA2010-5HM46-0AA0	952,—
3VA21	25	10 ... 25	38 ... 300	15 ... 25	B	3VA2125-5HM46-0AA0	900,—
	40	16 ... 40	60 ... 480	16 ... 40	B	3VA2140-5HM46-0AA0	900,—
	63	25 ... 63	95 ... 756	16 ... 63	B	3VA2163-5HM46-0AA0	900,—
	100	40 ... 100	150 ... 1200	20 ... 100	B	3VA2110-5HM46-0AA0	952,—
	160	63 ... 160	240 ... 1600	32 ... 160	B	3VA2116-5HM46-0AA0	1 310,—

Anschluss Schraubenflanschanschluss

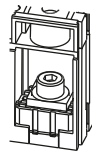

3VA20	25	10 ... 25	38 ... 300	15 ... 25	B	3VA2025-5HM42-0AA0	867,—
	40	16 ... 40	60 ... 480	16 ... 40	B	3VA2040-5HM42-0AA0	867,—
	63	25 ... 63	95 ... 756	16 ... 63	B	3VA2063-5HM42-0AA0	867,—
	100	40 ... 100	150 ... 1200	20 ... 100	B	3VA2010-5HM42-0AA0	919,—
3VA21	25	10 ... 25	38 ... 300	15 ... 25	B	3VA2125-5HM42-0AA0	867,—
	40	16 ... 40	60 ... 480	16 ... 40	B	3VA2140-5HM42-0AA0	867,—
	63	25 ... 63	95 ... 756	16 ... 63	B	3VA2163-5HM42-0AA0	867,—
	100	40 ... 100	150 ... 1200	20 ... 100	B	3VA2110-5HM42-0AA0	919,—
	160	63 ... 160	240 ... 1600	32 ... 160	B	3VA2116-5HM42-0AA0	1 270,—

3VA22	160	63 ... 160	240 ... 1920	32 ... 160	B	3VA2216-5HM42-0AA0	1 610,—
	250	100 ... 250	375 ... 2500	50 ... 250	B	3VA2225-5HM42-0AA0	1 610,—
3VA23	250	100 ... 250	375 ... 3000	50 ... 250	B	3VA2325-5HM42-0AA0	2 040,—
	400	160 ... 400	600 ... 4000	80 ... 400	B	3VA2340-5HM42-0AA0	2 150,—
3VA24	400	160 ... 400	600 ... 4800 ¹⁾	80 ... 400	B	3VA2440-5HM42-0AA0	2 580,—
	630	250 ... 630	945 ... 5670	126 ... 630	B	3VA2463-5HM42-0AA0	2 790,—

¹⁾ bei Schaltvermögen L 4400 A

Kompaktleistungsschalter 3VA2 bis 630 A, ETU, 400/690 V, bis 150 kA

Anlagenschutz

PE (ST, SZ, M) = 1

PKG*/VPE = 1 ST

PG = 12P

Bemes- sungs- strom I_n	LK	I_{cu} bis 85 kA bei 415 V, Hohes Schaltvermögen H H siehe "Übersicht", S. 1/6 und 1/7	Grund- preis € pro PE	LK	I_{cu} bis 110 kA bei 415 V, Sehr hohes Schaltvermögen C C siehe "Übersicht", S. 1/6 und 1/7	Grund- preis € pro PE	LK	I_{cu} bis 150 kA bei 415 V, Extrem hohes Schaltvermögen L L siehe "Übersicht", S. 1/6 und 1/7	Grund- preis € pro PE
A		Artikel-Nr. www.siemens.com/ product?Artikel-Nr.			Artikel-Nr. www.siemens.com/ product?Artikel-Nr.			Artikel-Nr. www.siemens.com/ product?Artikel-Nr.	

Anlagenschutz, ETU330 LIG

Mit einstellbarem Überlastauslöser I_r , einstellbarem unverzögerten Kurzschlussauslöser I_n , mit "N"-Überlast- und Kurzschlussauslöser 0 %, 50 % oder 100 % und einstellbarem Erdschlussauslöser I_g

Anschluss Rahmenklemme

25	B	3VA2025-6HM46-0AA0	974,—	B	3VA2025-7HM46-0AA0	1 100,—	B	3VA2025-8HM46-0AA0	1 200,—
40	B	3VA2040-6HM46-0AA0	974,—	B	3VA2040-7HM46-0AA0	1 100,—	B	3VA2040-8HM46-0AA0	1 200,—
63	B	3VA2063-6HM46-0AA0	974,—	B	3VA2063-7HM46-0AA0	1 100,—	B	3VA2063-8HM46-0AA0	1 200,—
100	B	3VA2010-6HM46-0AA0	1 030,—	B	3VA2010-7HM46-0AA0	1 170,—	B	3VA2010-8HM46-0AA0	1 290,—
25	B	3VA2125-6HM46-0AA0	974,—	B	3VA2125-7HM46-0AA0	1 100,—	B	3VA2125-8HM46-0AA0	1 200,—
40	B	3VA2140-6HM46-0AA0	974,—	B	3VA2140-7HM46-0AA0	1 100,—	B	3VA2140-8HM46-0AA0	1 200,—
63	B	3VA2163-6HM46-0AA0	974,—	B	3VA2163-7HM46-0AA0	1 100,—	B	3VA2163-8HM46-0AA0	1 200,—
100	B	3VA2110-6HM46-0AA0	1 030,—	B	3VA2110-7HM46-0AA0	1 170,—	B	3VA2110-8HM46-0AA0	1 290,—
160	B	3VA2116-6HM46-0AA0	1 400,—	B	3VA2116-7HM46-0AA0	1 570,—	B	3VA2116-8HM46-0AA0	1 720,—

Anschluss Schraubenflachanschluss

25	B	3VA2025-6HM42-0AA0	942,—	B	3VA2025-7HM42-0AA0	1 070,—	B	3VA2025-8HM42-0AA0	1 170,—
40	B	3VA2040-6HM42-0AA0	942,—	B	3VA2040-7HM42-0AA0	1 070,—	B	3VA2040-8HM42-0AA0	1 170,—
63	B	3VA2063-6HM42-0AA0	942,—	B	3VA2063-7HM42-0AA0	1 070,—	B	3VA2063-8HM42-0AA0	1 170,—
100	B	3VA2010-6HM42-0AA0	1 000,—	B	3VA2010-7HM42-0AA0	1 140,—	B	3VA2010-8HM42-0AA0	1 260,—
25	B	3VA2125-6HM42-0AA0	942,—	B	3VA2125-7HM42-0AA0	1 070,—	B	3VA2125-8HM42-0AA0	1 170,—
40	B	3VA2140-6HM42-0AA0	942,—	B	3VA2140-7HM42-0AA0	1 070,—	B	3VA2140-8HM42-0AA0	1 170,—
63	B	3VA2163-6HM42-0AA0	942,—	B	3VA2163-7HM42-0AA0	1 070,—	B	3VA2163-8HM42-0AA0	1 170,—
100	B	3VA2110-6HM42-0AA0	1 000,—	B	3VA2110-7HM42-0AA0	1 140,—	B	3VA2110-8HM42-0AA0	1 260,—
160	B	3VA2116-6HM42-0AA0	1 370,—	B	3VA2116-7HM42-0AA0	1 540,—	B	3VA2116-8HM42-0AA0	1 710,—
160	B	3VA2216-6HM42-0AA0	1 790,—	B	3VA2216-7HM42-0AA0	1 910,—	B	3VA2216-8HM42-0AA0	2 160,—
250	B	3VA2225-6HM42-0AA0	1 790,—	B	3VA2225-7HM42-0AA0	1 910,—	B	3VA2225-8HM42-0AA0	2 160,—
250	B	3VA2325-6HM42-0AA0	2 170,—	B	3VA2325-7HM42-0AA0	2 360,—	¹⁾ B	3VA2325-8HM42-0AA0	2 780,—
400	B	3VA2340-6HM42-0AA0	2 340,—	B	3VA2340-7HM42-0AA0	2 540,—	¹⁾ B	3VA2340-8HM42-0AA0	2 970,—
400	B	3VA2440-6HM42-0AA0	2 850,—	B	3VA2440-7HM42-0AA0	3 150,—	¹⁾ B	3VA2440-8HM42-0AA0	3 500,—
630	B	3VA2463-6HM42-0AA0	3 040,—	B	3VA2463-7HM42-0AA0	3 410,—	¹⁾ B	3VA2463-8HM42-0AA0	3 780,—

¹⁾ Liefereinsatz voraussichtlich 3. Quartal 2015

Kompaktleistungsschalter 3VA2 bis 630 A, ETU, 400/690 V, bis 150 kA

Anlagenschutz

PE (ST, SZ, M) = 1

PKG*/VPE = 1 ST

PG = 12P



Anschluss-technik	Typ	Bemes-sungs-strom I_n	Einstellstrom der strom-abhängig verzögerten Überlast-auslöser "L" I_r	S-Funktion (kurzzeitver-zögerter Kurz-schluss-schutz "S") I_{sd}	Ansprech-strom der unverzöger-ten Kurz-schluss-auslöser "I" I_i	LK
		A	A	A	A	

I_{cu} bis 55 kA bei 415 V, Mittleres Schaltvermögen M (M)
siehe "Übersicht", S. 1/6 und 1/7

Artikel-Nr. www.siemens.com/product?ArtikelNr. Grundpreis € pro PE

4-polig, Festeinbau, 3VA21 bis 3VA24, bis 630 A Elektronischer Überstromauslöser



I201_18427

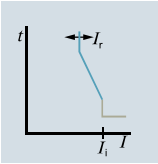

Anlagenschutz, ETU340 ELISA

Mit einfach einstellbarer Kennlinie (Kennlinienform einer Sicherung) mit "N"-Überlast- und Kurzschlussauslöser 0 % oder 100 %

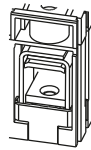

Anschluss Rahmenklemme

3VA21	25	10 ... 25	--	375	B
	40	16 ... 40	--	600	B
	63	25 ... 63	--	945	B
	100	40 ... 100	--	1500	B

3VA2125-5HK46-0AA0	655,—
3VA2140-5HK46-0AA0	655,—
3VA2163-5HK46-0AA0	655,—
3VA2110-5HK46-0AA0	709,—

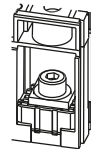

Anschluss Schraubenflanschanschluss

3VA21	25	10 ... 25	--	375	B
	40	16 ... 40	--	600	B
	63	25 ... 63	--	945	B
	100	40 ... 100	--	1500	B
3VA22	160	63 ... 160	--	2400	B
3VA23	250	100 ... 250	--	3750	B
3VA24	400	160 ... 400	--	6000 ¹⁾	B
	500	200 ... 500	--	7000	B
	630	250 ... 630	--	5670	B

3VA2125-5HK42-0AA0	622,—
3VA2140-5HK42-0AA0	622,—
3VA2163-5HK42-0AA0	622,—
3VA2110-5HK42-0AA0	676,—
3VA2216-5HK42-0AA0	1 330,—
3VA2325-5HK42-0AA0	1 750,—
3VA2440-5HK42-0AA0	2 330,—
3VA2450-5HK42-0AA0	2 440,—
3VA2463-5HK42-0AA0	2 530,—

¹⁾ bei Schaltvermögen L 4400 A

Kompaktleistungsschalter 3VA2 bis 630 A, ETU, 400/690 V, bis 150 kA

Anlagenschutz

PE (ST, SZ, M) = 1

PKG*/MPE = 1 ST

PG = 12P

Bemes- sungs- strom I_n	LK	I_{cu} bis 85 kA bei 415 V, Hohes Schaltvermögen H siehe "Übersicht", S. 1/6 und 1/7	(H)	LK	I_{cu} bis 110 kA bei 415 V, Sehr hohes Schaltvermögen C siehe "Übersicht", S. 1/6 und 1/7	(C)	LK	I_{cu} bis 150 kA bei 415 V, Extrem hohes Schaltvermögen L siehe "Übersicht", S. 1/6 und 1/7	(L)
A		Artikel-Nr. www.siemens.com/ product?Artikel-Nr.	Grund- preis € pro PE		Artikel-Nr. www.siemens.com/ product?Artikel-Nr.	Grund- preis € pro PE		Artikel-Nr. www.siemens.com/ product?Artikel-Nr.	Grund- preis € pro PE

Anlagenschutz, ETU340 ELISA

Mit einfach einstellbarer Kennlinie (Kennlinienform einer Sicherung)
mit "N"-Überlast- und Kurzschlussauslöser 0 % oder 100 %

Anschluss Rahmenklemme									
25	B	3VA2125-6HK46-0AA0	720,—	B	3VA2125-7HK46-0AA0	846,—	B	3VA2125-8HK46-0AA0	949,—
40	B	3VA2140-6HK46-0AA0	720,—	B	3VA2140-7HK46-0AA0	846,—	B	3VA2140-8HK46-0AA0	949,—
63	B	3VA2163-6HK46-0AA0	720,—	B	3VA2163-7HK46-0AA0	846,—	B	3VA2163-8HK46-0AA0	949,—
100	B	3VA2110-6HK46-0AA0	780,—	B	3VA2110-7HK46-0AA0	917,—	B	3VA2110-8HK46-0AA0	1 030,—
Anschluss Schraubenflanschanschluss									
25	B	3VA2125-6HK42-0AA0	687,—	B	3VA2125-7HK42-0AA0	813,—	B	3VA2125-8HK42-0AA0	916,—
40	B	3VA2140-6HK42-0AA0	687,—	B	3VA2140-7HK42-0AA0	813,—	B	3VA2140-8HK42-0AA0	916,—
63	B	3VA2163-6HK42-0AA0	687,—	B	3VA2163-7HK42-0AA0	813,—	B	3VA2163-8HK42-0AA0	916,—
100	B	3VA2110-6HK42-0AA0	747,—	B	3VA2110-7HK42-0AA0	884,—	B	3VA2110-8HK42-0AA0	996,—
160	B	3VA2216-6HK42-0AA0	1 520,—	B	3VA2216-7HK42-0AA0	1 660,—	B	3VA2216-8HK42-0AA0	1 880,—
250	B	3VA2325-6HK42-0AA0	1 920,—	B	3VA2325-7HK42-0AA0	2 100,—	¹⁾ B	3VA2325-8HK42-0AA0	2 500,—
400	B	3VA2440-6HK42-0AA0	2 590,—	B	3VA2440-7HK42-0AA0	2 900,—	¹⁾ B	3VA2440-8HK42-0AA0	3 240,—
500	B	3VA2450-6HK42-0AA0	2 780,—	B	3VA2450-7HK42-0AA0	3 010,—	¹⁾ B	3VA2450-8HK42-0AA0	3 470,—
630	B	3VA2463-6HK42-0AA0	2 820,—	B	3VA2463-7HK42-0AA0	3 150,—	¹⁾ B	3VA2463-8HK42-0AA0	3 520,—

¹⁾ Liefereinsatz voraussichtlich 3. Quartal 2015

Kompaktleistungsschalter 3VA2 bis 630 A, ETU, 400/690 V, bis 150 kA

Anlagenschutz

PE (ST, SZ, M) = 1

PKG*/VPE = 1 ST

PG = 12P



Anschluss-technik	Typ	Bemes-sungs-strom I_n	Einstellstrom der strom-abhängig verzögerten Überlast-auslöser "L" I_r	S-Funktion (kurzzeitver-zögerter Kurz-schluss-schutz "S") I_{sd}	Ansprech-strom der unverzö-geren Kurz-schluss-auslöser "I" I_i	LK
		A	A	A	A	

I_{cu} bis 55 kA bei 415 V, Mittleres Schaltvermögen M (M)
siehe "Übersicht", S. 1/6 und 1/7

Artikel-Nr. www.siemens.com/product?Artikel-Nr. Grundpreis € pro PE

4-polig, Festeinbau, 3VA20 bis 3VA24, bis 630 A Elektronischer Überstromauslöser



1201_18828

Anlagen- und Generatorschutz, ETU350 LSI

Mit einstellbarem Überlastauslöser I_r , einstellbarem verzögerten Kurzschlussauslöser I_{sd} und fest eingestelltem unverzögerten Kurzschlussauslöser I_i , mit "N"-Überlast- und Kurzschlussauslöser 0 %, 50 % oder 100 %

$I_r \times \dots$

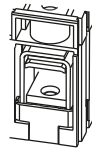
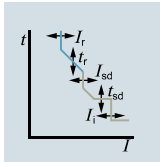

Anschluss Rahmenklemme

3VA20	25	10 ... 25	1,5 ... 10	300	B	3VA2025-5HN46-0AA0	724,—
	40	16 ... 40	1,5 ... 10	480	B	3VA2040-5HN46-0AA0	724,—
	63	25 ... 63	1,5 ... 10	756	B	3VA2063-5HN46-0AA0	724,—
	100	40 ... 100	1,5 ... 10	1200	B	3VA2010-5HN46-0AA0	784,—
3VA21	25	10 ... 25	1,5 ... 10	300	B	3VA2125-5HN46-0AA0	724,—
	40	16 ... 40	1,5 ... 10	480	B	3VA2140-5HN46-0AA0	724,—
	63	25 ... 63	1,5 ... 10	756	B	3VA2163-5HN46-0AA0	724,—
	100	40 ... 100	1,5 ... 10	1200	B	3VA2110-5HN46-0AA0	784,—
	160	63 ... 160	1,5 ... 10	1600	B	3VA2116-5HN46-0AA0	1 160,—

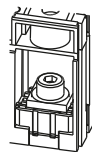

Anschluss Schraubenflanschanschluss

3VA20	25	10 ... 25	1,5 ... 10	300	B	3VA2025-5HN42-0AA0	691,—
	40	16 ... 40	1,5 ... 10	480	B	3VA2040-5HN42-0AA0	691,—
	63	25 ... 63	1,5 ... 10	756	B	3VA2063-5HN42-0AA0	691,—
	100	40 ... 100	1,5 ... 10	1200	B	3VA2010-5HN42-0AA0	751,—
3VA21	25	10 ... 25	1,5 ... 10	300	B	3VA2125-5HN42-0AA0	691,—
	40	16 ... 40	1,5 ... 10	480	B	3VA2140-5HN42-0AA0	691,—
	63	25 ... 63	1,5 ... 10	756	B	3VA2163-5HN42-0AA0	691,—
	100	40 ... 100	1,5 ... 10	1200	B	3VA2110-5HN42-0AA0	751,—
	160	63 ... 160	1,5 ... 10	1600	B	3VA2116-5HN42-0AA0	1 130,—
3VA22	160	63 ... 160	1,5 ... 10	1920	B	3VA2216-5HN42-0AA0	1 480,—
	250	100 ... 250	1,5 ... 10	2500	B	3VA2225-5HN42-0AA0	1 480,—
3VA23	250	100 ... 250	1,5 ... 10	3000	B	3VA2325-5HN42-0AA0	1 970,—
	400	160 ... 400	1,5 ... 10	4000	B	3VA2340-5HN42-0AA0	2 130,—
3VA24	400	160 ... 400	1,5 ... 10	4800 ¹⁾	B	3VA2440-5HN42-0AA0	2 590,—
	630	250 ... 630	1,5 ... 9	5670	B	3VA2463-5HN42-0AA0	2 820,—

¹⁾ bei Schaltvermögen L 4400 A

3

Kompaktleistungsschalter 3VA2 bis 630 A, ETU, 400/690 V, bis 150 kA

Anlagenschutz

PE (ST, SZ, M) = 1

PKG*/VPE = 1 ST

PG = 12P

Bemes- sungs- strom I_n	LK	I_{cu} bis 85 kA bei 415 V, Hohes Schaltvermögen H H	LK	I_{cu} bis 110 kA bei 415 V, Sehr hohes Schaltvermögen C C	LK	I_{cu} bis 150 kA bei 415 V, Extrem hohes Schaltvermögen L L	
		Artikel-Nr. www.siemens.com/ product?Artikel-Nr.	Grund- preis € pro PE	Artikel-Nr. www.siemens.com/ product?Artikel-Nr.	Grund- preis € pro PE	Artikel-Nr. www.siemens.com/ product?Artikel-Nr.	Grund- preis € pro PE
A							

Anlagen- und Generatorschutz, ETU350 LSI

Mit einstellbarem Überlastauslöser I_n , einstellbarem verzögerten Kurzschlussauslöser I_{sd} und fest eingestelltem unverzögerten Kurzschlussauslöser I_i , mit "N"-Überlast- und Kurzschlussauslöser 0 %, 50 % oder 100 %

Anschluss Rahmenklemme

25	B	3VA2025-6HN46-0AA0	796,—	B	3VA2025-7HN46-0AA0	936,—	B	3VA2025-8HN46-0AA0	1 050,—
40	B	3VA2040-6HN46-0AA0	796,—	B	3VA2040-7HN46-0AA0	936,—	B	3VA2040-8HN46-0AA0	1 050,—
63	B	3VA2063-6HN46-0AA0	796,—	B	3VA2063-7HN46-0AA0	936,—	B	3VA2063-8HN46-0AA0	1 050,—
100	B	3VA2010-6HN46-0AA0	862,—	B	3VA2010-7HN46-0AA0	1 010,—	B	3VA2010-8HN46-0AA0	1 140,—
25	B	3VA2125-6HN46-0AA0	796,—	B	3VA2125-7HN46-0AA0	936,—	B	3VA2125-8HN46-0AA0	1 050,—
40	B	3VA2140-6HN46-0AA0	796,—	B	3VA2140-7HN46-0AA0	936,—	B	3VA2140-8HN46-0AA0	1 050,—
63	B	3VA2163-6HN46-0AA0	796,—	B	3VA2163-7HN46-0AA0	936,—	B	3VA2163-8HN46-0AA0	1 050,—
100	B	3VA2110-6HN46-0AA0	862,—	B	3VA2110-7HN46-0AA0	1 010,—	B	3VA2110-8HN46-0AA0	1 140,—
160	B	3VA2116-6HN46-0AA0	1 270,—	B	3VA2116-7HN46-0AA0	1 460,—	B	3VA2116-8HN46-0AA0	1 650,—

Anschluss Schraubenflachanschluss

25	B	3VA2025-6HN42-0AA0	764,—	B	3VA2025-7HN42-0AA0	903,—	B	3VA2025-8HN42-0AA0	1 020,—
40	B	3VA2040-6HN42-0AA0	764,—	B	3VA2040-7HN42-0AA0	903,—	B	3VA2040-8HN42-0AA0	1 020,—
63	B	3VA2063-6HN42-0AA0	764,—	B	3VA2063-7HN42-0AA0	903,—	B	3VA2063-8HN42-0AA0	1 020,—
100	B	3VA2010-6HN42-0AA0	829,—	B	3VA2010-7HN42-0AA0	982,—	B	3VA2010-8HN42-0AA0	1 110,—
25	B	3VA2125-6HN42-0AA0	764,—	B	3VA2125-7HN42-0AA0	903,—	B	3VA2125-8HN42-0AA0	1 020,—
40	B	3VA2140-6HN42-0AA0	764,—	B	3VA2140-7HN42-0AA0	903,—	B	3VA2140-8HN42-0AA0	1 020,—
63	B	3VA2163-6HN42-0AA0	764,—	B	3VA2163-7HN42-0AA0	903,—	B	3VA2163-8HN42-0AA0	1 020,—
100	B	3VA2110-6HN42-0AA0	829,—	B	3VA2110-7HN42-0AA0	982,—	B	3VA2110-8HN42-0AA0	1 110,—
160	B	3VA2116-6HN42-0AA0	1 230,—	B	3VA2116-7HN42-0AA0	1 430,—	B	3VA2116-8HN42-0AA0	1 620,—
160	B	3VA2216-6HN42-0AA0	1 690,—	B	3VA2216-7HN42-0AA0	1 840,—	B	3VA2216-8HN42-0AA0	2 080,—
250	B	3VA2225-6HN42-0AA0	1 690,—	B	3VA2225-7HN42-0AA0	1 840,—	B	3VA2225-8HN42-0AA0	2 080,—
250	B	3VA2325-6HN42-0AA0	2 130,—	B	3VA2325-7HN42-0AA0	2 340,—	¹⁾ B	3VA2325-8HN42-0AA0	2 700,—
400	B	3VA2340-6HN42-0AA0	2 340,—	B	3VA2340-7HN42-0AA0	2 540,—	¹⁾ B	3VA2340-8HN42-0AA0	2 920,—
400	B	3VA2440-6HN42-0AA0	2 880,—	B	3VA2440-7HN42-0AA0	3 110,—	¹⁾ B	3VA2440-8HN42-0AA0	3 510,—
630	B	3VA2463-6HN42-0AA0	3 130,—	B	3VA2463-7HN42-0AA0	3 400,—	¹⁾ B	3VA2463-8HN42-0AA0	3 810,—

¹⁾ Liefereinsatz voraussichtlich 3. Quartal 2015

Kompaktleistungsschalter 3VA2 bis 630 A, ETU, 400/690 V, bis 150 kA

Anlagenschutz

PE (ST, SZ, M) = 1

PKG*/VPE = 1 ST

PG = 12P



Anschluss-technik	Typ	Bemes-sungs-strom I_n	Einstellstrom der strom-abhängig verzögerten Überlast-auslöser "L" I_r	S-Funktion (kurzzeitver-zögerter Kurzschluss-schutz "S") I_{sd}	Ansprech-strom der un-verzögerten Kurzschluss-auslöser "I" I_i	LK
		A	A	A	A	

I_{cu} bis 55 kA bei 415 V, Mittleres Schaltvermögen M
siehe "Übersicht", S. 1/6 und 1/7

Artikel-Nr. www.siemens.com/product?Artikel-Nr. Grundpreis € pro PE

4-polig, Festeinbau, 3VA20 bis 3VA24, bis 630 A Elektronischer Überstromauslöser

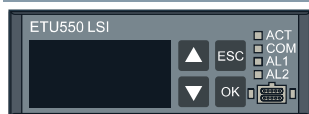

1201_18480

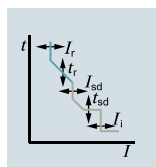

Anlagen- und Generatorschutz, mit Anzeige, ETU550 LSI

Mit einstellbarem Überlastauslöser I_r , einstellbarem verzögerten Kurzschlussauslöser I_{sd} und einstellbarem unverzögerten Kurzschlussauslöser I_i , mit "N"-Überlast- und Kurzschlussauslöser von 20%/40% bis 100%/160%

Anschluss Rahmenklemme

3VA20	25	10 ... 25	15 ... 250	38 ... 300	B	3VA2025-5JP46-0AA0	1 150,—
	40	16 ... 40	24 ... 400	60 ... 480	B	3VA2040-5JP46-0AA0	1 150,—
	63	25 ... 63	38 ... 630	95 ... 756	B	3VA2063-5JP46-0AA0	1 150,—
	100	40 ... 100	60 ... 1000	150 ... 1200	B	3VA2010-5JP46-0AA0	1 210,—
3VA21	25	10 ... 25	15 ... 250	38 ... 300	B	3VA2125-5JP46-0AA0	1 150,—
	40	16 ... 40	24 ... 400	60 ... 480	B	3VA2140-5JP46-0AA0	1 150,—
	63	25 ... 63	38 ... 630	95 ... 756	B	3VA2163-5JP46-0AA0	1 150,—
	100	40 ... 100	60 ... 1000	150 ... 1200	B	3VA2110-5JP46-0AA0	1 210,—
	160	63 ... 160	96 ... 1600	240 ... 1600	B	3VA2116-5JP46-0AA0	1 590,—

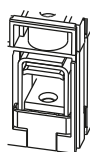

Anschluss Schraubenflanschanschluss

3VA20	25	10 ... 25	15 ... 250	38 ... 300	B	3VA2025-5JP42-0AA0	1 120,—
	40	16 ... 40	24 ... 400	60 ... 480	B	3VA2040-5JP42-0AA0	1 120,—
	63	25 ... 63	38 ... 630	95 ... 756	B	3VA2063-5JP42-0AA0	1 120,—
	100	40 ... 100	60 ... 1000	150 ... 1200	B	3VA2010-5JP42-0AA0	1 170,—
3VA21	25	10 ... 25	15 ... 250	38 ... 300	B	3VA2125-5JP42-0AA0	1 120,—
	40	16 ... 40	24 ... 400	60 ... 480	B	3VA2140-5JP42-0AA0	1 120,—
	63	25 ... 63	38 ... 630	95 ... 756	B	3VA2163-5JP42-0AA0	1 120,—
	100	40 ... 100	60 ... 1000	150 ... 1200	B	3VA2110-5JP42-0AA0	1 170,—
	160	63 ... 160	96 ... 1600	240 ... 1600	B	3VA2116-5JP42-0AA0	1 560,—
3VA22	160	63 ... 160	96 ... 1600	240 ... 1920	B	3VA2216-5JP42-0AA0	1 910,—
	250	100 ... 250	150 ... 2500	375 ... 2500	B	3VA2225-5JP42-0AA0	1 910,—
3VA23	250	100 ... 250	150 ... 2500	375 ... 3000	B	3VA2325-5JP42-0AA0	2 390,—
	400	160 ... 400	240 ... 4000	600 ... 4000	B	3VA2340-5JP42-0AA0	2 560,—
3VA24	400	160 ... 400	240 ... 4000	600 ... 6000 ¹⁾	B	3VA2440-5JP42-0AA0	3 010,—
	500	200 ... 500	300 ... 5000	750 ... 7000	B	3VA2450-5JP42-0AA0	3 010,—
	630	250 ... 630	378 ... 5670	945 ... 5670	B	3VA2463-5JP42-0AA0	3 240,—

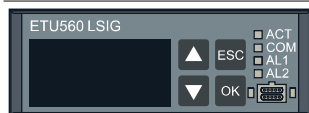
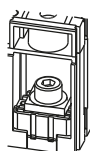

1201_18481

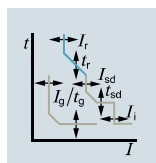

Anlagen- und Generatorschutz, mit Anzeige, ETU560 LSI

Mit einstellbarem Überlastauslöser I_r , einstellbarem verzögerten Kurzschlussauslöser I_{sd} und einstellbarem unverzögerten Kurzschlussauslöser I_i , mit "N"-Überlast- und Kurzschlussauslöser von 20%/40% bis 100%/160% und einstellbarem Erdschlussauslöser I_g

Anschluss Rahmenklemme

3VA20	25	10 ... 25	15 ... 250	38 ... 300	B	3VA2025-5JQ46-0AA0	1 390,—
	40	16 ... 40	24 ... 400	60 ... 480	B	3VA2040-5JQ46-0AA0	1 390,—
	63	25 ... 63	38 ... 630	95 ... 756	B	3VA2063-5JQ46-0AA0	1 390,—
	100	40 ... 100	60 ... 1000	150 ... 1200	B	3VA2010-5JQ46-0AA0	1 440,—
3VA21	25	10 ... 25	15 ... 250	38 ... 300	B	3VA2125-5JQ46-0AA0	1 390,—
	40	16 ... 40	24 ... 400	60 ... 480	B	3VA2140-5JQ46-0AA0	1 390,—
	63	25 ... 63	38 ... 630	95 ... 756	B	3VA2163-5JQ46-0AA0	1 390,—
	100	40 ... 100	60 ... 1000	150 ... 1200	B	3VA2110-5JQ46-0AA0	1 440,—
	160	63 ... 160	96 ... 1600	240 ... 1600	B	3VA2116-5JQ46-0AA0	1 850,—

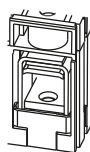

Anschluss Schraubenflanschanschluss

3VA20	25	10 ... 25	15 ... 250	38 ... 300	B	3VA2025-5JQ42-0AA0	1 360,—
	40	16 ... 40	24 ... 400	60 ... 480	B	3VA2040-5JQ42-0AA0	1 360,—
	63	25 ... 63	38 ... 630	95 ... 756	B	3VA2063-5JQ42-0AA0	1 360,—
	100	40 ... 100	60 ... 1000	150 ... 1200	B	3VA2010-5JQ42-0AA0	1 410,—
3VA21	25	10 ... 25	15 ... 250	38 ... 300	B	3VA2125-5JQ42-0AA0	1 360,—
	40	16 ... 40	24 ... 400	60 ... 480	B	3VA2140-5JQ42-0AA0	1 360,—
	63	25 ... 63	38 ... 630	95 ... 756	B	3VA2163-5JQ42-0AA0	1 360,—
	100	40 ... 100	60 ... 1000	150 ... 1200	B	3VA2110-5JQ42-0AA0	1 410,—
	160	63 ... 160	96 ... 1600	240 ... 1600	B	3VA2116-5JQ42-0AA0	1 810,—
3VA22	160	63 ... 160	96 ... 1600	240 ... 1920	B	3VA2216-5JQ42-0AA0	2 160,—
	250	100 ... 250	150 ... 2500	375 ... 2500	B	3VA2225-5JQ42-0AA0	2 160,—
3VA23	250	100 ... 250	150 ... 2500	375 ... 3000	B	3VA2325-5JQ42-0AA0	2 640,—
	400	160 ... 400	240 ... 4000	600 ... 4000	B	3VA2340-5JQ42-0AA0	2 820,—
3VA24	400	160 ... 400	240 ... 4000	600 ... 6000 ¹⁾	B	3VA2440-5JQ42-0AA0	3 270,—
	500	200 ... 500	300 ... 5000	750 ... 7000	B	3VA2450-5JQ42-0AA0	3 270,—
	630	250 ... 630	378 ... 5670	945 ... 5670	B	3VA2463-5JQ42-0AA0	3 500,—

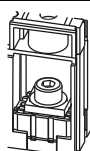

¹⁾ bei Schaltvermögen L 4400 A

Kompaktleistungsschalter 3VA2 bis 630 A, ETU, 400/690 V, bis 150 kA

Anlagenschutz

PE (ST, SZ, M) = 1

PKG*/VPE = 1 ST

PG = 12P

Bemes- sungs- strom I_n	LK	I_{cu} bis 85 kA bei 415 V, Hohes Schaltvermögen H siehe "Übersicht", S. 1/6 und 1/7	(H)	LK	I_{cu} bis 110 kA bei 415 V, Sehr hohes Schaltvermögen C siehe "Übersicht", S. 1/6 und 1/7	(C)	LK	I_{cu} bis 150 kA bei 415 V, Extrem hohes Schaltvermögen L siehe "Übersicht", S. 1/6 und 1/7	(L)
		Artikel-Nr. www.siemens.com/ product?Artikel-Nr.	Grund- preis € pro PE		Artikel-Nr. www.siemens.com/ product?Artikel-Nr.	Grund- preis € pro PE		Artikel-Nr. www.siemens.com/ product?Artikel-Nr.	Grund- preis € pro PE
A									

Anlagen- und Generatorschutz, mit Anzeige, ETU550 LSI

Mit einstellbarem Überlastauslöser I_r , einstellbarem verzögerten Kurzschlussauslöser I_{sd}
und einstellbarem unverzögerten Kurzschlussauslöser I_i ,
mit "N"-Überlast- und Kurzschlussauslöser von 20%/40% bis 100%/160%

Anschluss Rahmenklemme

25	B	3VA2025-6JP46-0AA0	1 220,—	B	3VA2025-7JP46-0AA0	1 360,—	B	3VA2025-8JP46-0AA0	1 470,—
40	B	3VA2040-6JP46-0AA0	1 220,—	B	3VA2040-7JP46-0AA0	1 360,—	B	3VA2040-8JP46-0AA0	1 470,—
63	B	3VA2063-6JP46-0AA0	1 220,—	B	3VA2063-7JP46-0AA0	1 360,—	B	3VA2063-8JP46-0AA0	1 470,—
100	B	3VA2010-6JP46-0AA0	1 290,—	B	3VA2010-7JP46-0AA0	1 440,—	B	3VA2010-8JP46-0AA0	1 560,—
25	B	3VA2125-6JP46-0AA0	1 220,—	B	3VA2125-7JP46-0AA0	1 360,—	B	3VA2125-8JP46-0AA0	1 470,—
40	B	3VA2140-6JP46-0AA0	1 220,—	B	3VA2140-7JP46-0AA0	1 360,—	B	3VA2140-8JP46-0AA0	1 470,—
63	B	3VA2163-6JP46-0AA0	1 220,—	B	3VA2163-7JP46-0AA0	1 360,—	B	3VA2163-8JP46-0AA0	1 470,—
100	B	3VA2110-6JP46-0AA0	1 290,—	B	3VA2110-7JP46-0AA0	1 440,—	B	3VA2110-8JP46-0AA0	1 560,—
160	B	3VA2116-6JP46-0AA0	1 680,—	B	3VA2116-7JP46-0AA0	1 890,—	B	3VA2116-8JP46-0AA0	2 070,—

Anschluss Schraubenflanschanschluss

25	B	3VA2025-6JP42-0AA0	1 190,—	B	3VA2025-7JP42-0AA0	1 330,—	B	3VA2025-8JP42-0AA0	1 440,—
40	B	3VA2040-6JP42-0AA0	1 190,—	B	3VA2040-7JP42-0AA0	1 330,—	B	3VA2040-8JP42-0AA0	1 440,—
63	B	3VA2063-6JP42-0AA0	1 190,—	B	3VA2063-7JP42-0AA0	1 330,—	B	3VA2063-8JP42-0AA0	1 440,—
100	B	3VA2010-6JP42-0AA0	1 260,—	B	3VA2010-7JP42-0AA0	1 410,—	B	3VA2010-8JP42-0AA0	1 530,—
25	B	3VA2125-6JP42-0AA0	1 190,—	B	3VA2125-7JP42-0AA0	1 330,—	B	3VA2125-8JP42-0AA0	1 440,—
40	B	3VA2140-6JP42-0AA0	1 190,—	B	3VA2140-7JP42-0AA0	1 330,—	B	3VA2140-8JP42-0AA0	1 440,—
63	B	3VA2163-6JP42-0AA0	1 190,—	B	3VA2163-7JP42-0AA0	1 330,—	B	3VA2163-8JP42-0AA0	1 440,—
100	B	3VA2110-6JP42-0AA0	1 260,—	B	3VA2110-7JP42-0AA0	1 410,—	B	3VA2110-8JP42-0AA0	1 530,—
160	B	3VA2116-6JP42-0AA0	1 640,—	B	3VA2116-7JP42-0AA0	1 860,—	B	3VA2116-8JP42-0AA0	2 040,—
160	B	3VA2216-6JP42-0AA0	2 110,—	B	3VA2216-7JP42-0AA0	2 270,—	B	3VA2216-8JP42-0AA0	2 510,—
250	B	3VA2225-6JP42-0AA0	2 110,—	B	3VA2225-7JP42-0AA0	2 270,—	B	3VA2225-8JP42-0AA0	2 510,—
250	B	3VA2325-6JP42-0AA0	2 550,—	B	3VA2325-7JP42-0AA0	2 720,—	¹⁾ B	3VA2325-8JP42-0AA0	3 120,—
400	B	3VA2340-6JP42-0AA0	2 760,—	B	3VA2340-7JP42-0AA0	2 960,—	¹⁾ B	3VA2340-8JP42-0AA0	3 350,—
400	B	3VA2440-6JP42-0AA0	3 300,—	B	3VA2440-7JP42-0AA0	3 530,—	¹⁾ B	3VA2440-8JP42-0AA0	3 930,—
500	B	3VA2450-6JP42-0AA0	3 300,—	B	3VA2450-7JP42-0AA0	3 530,—		---	
630	B	3VA2463-6JP42-0AA0	3 560,—	B	3VA2463-7JP42-0AA0	3 830,—	¹⁾ B	3VA2463-8JP42-0AA0	4 240,—

Anlagen- und Generatorschutz, mit Anzeige, ETU560 LSI G

Mit einstellbarem Überlastauslöser I_r , einstellbarem verzögerten Kurzschlussauslöser I_{sd}
und einstellbarem unverzögerten Kurzschlussauslöser I_i ,
mit "N"-Überlast- und Kurzschlussauslöser von 20%/40% bis 100%/160%
und einstellbarem Erdschlussauslöser I_G

Anschluss Rahmenklemme

25	B	3VA2025-6JQ46-0AA0	1 460,—	B	3VA2025-7JQ46-0AA0	1 620,—	B	3VA2025-8JQ46-0AA0	1 730,—
40	B	3VA2040-6JQ46-0AA0	1 460,—	B	3VA2040-7JQ46-0AA0	1 620,—	B	3VA2040-8JQ46-0AA0	1 730,—
63	B	3VA2063-6JQ46-0AA0	1 460,—	B	3VA2063-7JQ46-0AA0	1 620,—	B	3VA2063-8JQ46-0AA0	1 730,—
100	B	3VA2010-6JQ46-0AA0	1 540,—	B	3VA2010-7JQ46-0AA0	1 700,—	B	3VA2010-8JQ46-0AA0	1 820,—
25	B	3VA2125-6JQ46-0AA0	1 460,—	B	3VA2125-7JQ46-0AA0	1 620,—	B	3VA2125-8JQ46-0AA0	1 730,—
40	B	3VA2140-6JQ46-0AA0	1 460,—	B	3VA2140-7JQ46-0AA0	1 620,—	B	3VA2140-8JQ46-0AA0	1 730,—
63	B	3VA2163-6JQ46-0AA0	1 460,—	B	3VA2163-7JQ46-0AA0	1 620,—	B	3VA2163-8JQ46-0AA0	1 730,—
100	B	3VA2110-6JQ46-0AA0	1 540,—	B	3VA2110-7JQ46-0AA0	1 700,—	B	3VA2110-8JQ46-0AA0	1 820,—
160	B	3VA2116-6JQ46-0AA0	1 920,—	B	3VA2116-7JQ46-0AA0	2 140,—	B	3VA2116-8JQ46-0AA0	2 330,—

Anschluss Schraubenflanschanschluss

25	B	3VA2025-6JQ42-0AA0	1 430,—	B	3VA2025-7JQ42-0AA0	1 580,—	B	3VA2025-8JQ42-0AA0	1 700,—
40	B	3VA2040-6JQ42-0AA0	1 430,—	B	3VA2040-7JQ42-0AA0	1 580,—	B	3VA2040-8JQ42-0AA0	1 700,—
63	B	3VA2063-6JQ42-0AA0	1 430,—	B	3VA2063-7JQ42-0AA0	1 580,—	B	3VA2063-8JQ42-0AA0	1 700,—
100	B	3VA2010-6JQ42-0AA0	1 510,—	B	3VA2010-7JQ42-0AA0	1 670,—	B	3VA2010-8JQ42-0AA0	1 790,—
25	B	3VA2125-6JQ42-0AA0	1 430,—	B	3VA2125-7JQ42-0AA0	1 580,—	B	3VA2125-8JQ42-0AA0	1 700,—
40	B	3VA2140-6JQ42-0AA0	1 430,—	B	3VA2140-7JQ42-0AA0	1 580,—	B	3VA2140-8JQ42-0AA0	1 700,—
63	B	3VA2163-6JQ42-0AA0	1 430,—	B	3VA2163-7JQ42-0AA0	1 580,—	B	3VA2163-8JQ42-0AA0	1 700,—
100	B	3VA2110-6JQ42-0AA0	1 510,—	B	3VA2110-7JQ42-0AA0	1 670,—	B	3VA2110-8JQ42-0AA0	1 790,—
160	B	3VA2116-6JQ42-0AA0	1 890,—	B	3VA2116-7JQ42-0AA0	2 110,—	B	3VA2116-8JQ42-0AA0	2 290,—
160	B	3VA2216-6JQ42-0AA0	2 370,—	B	3VA2216-7JQ42-0AA0	2 530,—	B	3VA2216-8JQ42-0AA0	2 770,—
250	B	3VA2225-6JQ42-0AA0	2 370,—	B	3VA2225-7JQ42-0AA0	2 530,—	B	3VA2225-8JQ42-0AA0	2 770,—
250	B	3VA2325-6JQ42-0AA0	2 810,—	B	3VA2325-7JQ42-0AA0	2 970,—	¹⁾ B	3VA2325-8JQ42-0AA0	3 380,—
400	B	3VA2340-6JQ42-0AA0	3 010,—	B	3VA2340-7JQ42-0AA0	3 220,—	¹⁾ B	3VA2340-8JQ42-0AA0	3 610,—
400	B	3VA2440-6JQ42-0AA0	3 560,—	B	3VA2440-7JQ42-0AA0	3 790,—	¹⁾ B	3VA2440-8JQ42-0AA0	4 250,—
500	B	3VA2450-6JQ42-0AA0	3 560,—	B	3VA2450-7JQ42-0AA0	3 790,—		---	
630	B	3VA2463-6JQ42-0AA0	3 810,—	B	3VA2463-7JQ42-0AA0	4 070,—	¹⁾ B	3VA2463-8JQ42-0AA0	4 500,—

¹⁾ Liefereinsatz voraussichtlich 3. Quartal 2015

* Diese Menge oder ein Vielfaches dieser Menge kann bestellt werden.
Unverbindliche Preisempfehlungen, ggf. zuzüglich Metallzuschläge (MZ)

Kompaktleistungsschalter 3VA2 bis 630 A, ETU, 400/690 V, bis 150 kA

Anlagenschutz

PE (ST, SZ, M) = 1

PKG*/VPE = 1 ST

PG = 12P



Anschluss-technik	Typ	Bemes-sungs-strom I_n	Einstellstrom der strom-abhängig verzögerten Überlast-auslöser "L" I_r	S-Funktion (kurzzeitver-zögerter Kurzsch-lussaus-löser "S") I_{sd}	Ansprech-strom der un-verzögerten Kurzschluss-auslöser "I" I_i	LK
		A	A	A	A	

I_{cu} bis 55 kA bei 415 V, Mittleres Schaltvermögen M
siehe "Übersicht", S. 1/6 und 1/7

Artikel-Nr. www.siemens.com/product?Artikel-Nr. Grundpreis € pro PE

4-polig, Festeinbau, 3VA20 bis 3VA24, bis 630 A Elektronischer Überstromauslöser

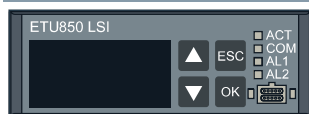

1201_18482

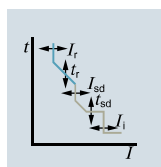

Anlagen- und Generatorschutz, mit Anzeige, mit Messfunktion, ETU850 LSI

Mit einstellbarem Überlastauslöser I_r , einstellbarem verzögerten Kurzschlussauslöser I_{sd} und einstellbarem unverzögerten Kurzschlussauslöser I_i , mit "N"-Überlast- und Kurzschlussauslöser von 20%/40% bis 100%/160%

Anschluss Rahmenklemme

3VA20	25	10 ... 25	15 ... 250	38 ... 300	B	3VA2025-5KP46-0AA0	1 260,—
	40	16 ... 40	24 ... 400	60 ... 480	B	3VA2040-5KP46-0AA0	1 260,—
	63	25 ... 63	38 ... 630	95 ... 756	B	3VA2063-5KP46-0AA0	1 260,—
	100	40 ... 100	60 ... 1000	150 ... 1200	B	3VA2010-5KP46-0AA0	1 320,—
3VA21	25	10 ... 25	15 ... 250	38 ... 300	B	3VA2125-5KP46-0AA0	1 260,—
	40	16 ... 40	24 ... 400	60 ... 480	B	3VA2140-5KP46-0AA0	1 260,—
	63	25 ... 63	38 ... 630	95 ... 756	B	3VA2163-5KP46-0AA0	1 260,—
	100	40 ... 100	60 ... 1000	150 ... 1200	B	3VA2110-5KP46-0AA0	1 320,—
	160	63 ... 160	96 ... 1600	240 ... 1600	B	3VA2116-5KP46-0AA0	1 700,—

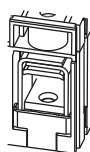

Anschluss Schraubenflanschanschluss

3VA20	25	10 ... 25	15 ... 250	38 ... 300	B	3VA2025-5KP42-0AA0	1 220,—
	40	16 ... 40	24 ... 400	60 ... 480	B	3VA2040-5KP42-0AA0	1 220,—
	63	25 ... 63	38 ... 630	95 ... 756	B	3VA2063-5KP42-0AA0	1 220,—
	100	40 ... 100	60 ... 1000	150 ... 1200	B	3VA2010-5KP42-0AA0	1 280,—
3VA21	25	10 ... 25	15 ... 250	38 ... 300	B	3VA2125-5KP42-0AA0	1 220,—
	40	16 ... 40	24 ... 400	60 ... 480	B	3VA2140-5KP42-0AA0	1 220,—
	63	25 ... 63	38 ... 630	95 ... 756	B	3VA2163-5KP42-0AA0	1 220,—
	100	40 ... 100	60 ... 1000	150 ... 1200	B	3VA2110-5KP42-0AA0	1 280,—
	160	63 ... 160	96 ... 1600	240 ... 1600	B	3VA2116-5KP42-0AA0	1 670,—
3VA22	160	63 ... 160	96 ... 1600	240 ... 1920	B	3VA2216-5KP42-0AA0	2 050,—
	250	100 ... 250	150 ... 2500	375 ... 2500	B	3VA2225-5KP42-0AA0	2 050,—
3VA23	250	100 ... 250	150 ... 2500	375 ... 3000	B	3VA2325-5KP42-0AA0	2 520,—
	400	160 ... 400	240 ... 4000	600 ... 4000	B	3VA2340-5KP42-0AA0	2 670,—
3VA24	400	160 ... 400	240 ... 4000	600 ... 6000 ¹⁾	B	3VA2440-5KP42-0AA0	3 120,—
	500	200 ... 500	300 ... 5000	750 ... 7000	B	3VA2450-5KP42-0AA0	3 120,—
	630	250 ... 630	378 ... 5670	945 ... 5670	B	3VA2463-5KP42-0AA0	3 340,—

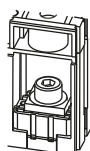

1201_18483

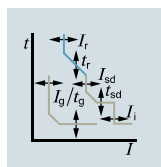

Anlagen- und Generatorschutz, mit Anzeige, mit Messfunktion, ETU860 LSI

Mit einstellbarem Überlastauslöser I_r , einstellbarem verzögerten Kurzschlussauslöser I_{sd} und einstellbarem unverzögerten Kurzschlussauslöser I_i , mit "N"-Überlast- und Kurzschlussauslöser von 20%/40% bis 100%/160% und einstellbarem Erdschlussauslöser I_g

Anschluss Rahmenklemme

3VA20	25	10 ... 25	15 ... 250	38 ... 300	B	3VA2025-5KQ46-0AA0	1 490,—
	40	16 ... 40	24 ... 400	60 ... 480	B	3VA2040-5KQ46-0AA0	1 490,—
	63	25 ... 63	38 ... 630	95 ... 756	B	3VA2063-5KQ46-0AA0	1 490,—
	100	40 ... 100	60 ... 1000	150 ... 1200	B	3VA2010-5KQ46-0AA0	1 560,—
3VA21	25	10 ... 25	15 ... 250	38 ... 300	B	3VA2125-5KQ46-0AA0	1 490,—
	40	16 ... 40	24 ... 400	60 ... 480	B	3VA2140-5KQ46-0AA0	1 490,—
	63	25 ... 63	38 ... 630	95 ... 756	B	3VA2163-5KQ46-0AA0	1 490,—
	100	40 ... 100	60 ... 1000	150 ... 1200	B	3VA2110-5KQ46-0AA0	1 560,—
	160	63 ... 160	96 ... 1600	240 ... 1600	B	3VA2116-5KQ46-0AA0	1 960,—

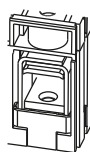

Anschluss Schraubenflanschanschluss

3VA20	25	10 ... 25	15 ... 250	38 ... 300	B	3VA2025-5KQ42-0AA0	1 450,—
	40	16 ... 40	24 ... 400	60 ... 480	B	3VA2040-5KQ42-0AA0	1 450,—
	63	25 ... 63	38 ... 630	95 ... 756	B	3VA2063-5KQ42-0AA0	1 450,—
	100	40 ... 100	60 ... 1000	150 ... 1200	B	3VA2010-5KQ42-0AA0	1 530,—
3VA21	25	10 ... 25	15 ... 250	38 ... 300	B	3VA2125-5KQ42-0AA0	1 450,—
	40	16 ... 40	24 ... 400	60 ... 480	B	3VA2140-5KQ42-0AA0	1 450,—
	63	25 ... 63	38 ... 630	95 ... 756	B	3VA2163-5KQ42-0AA0	1 450,—
	100	40 ... 100	60 ... 1000	150 ... 1200	B	3VA2110-5KQ42-0AA0	1 530,—
	160	63 ... 160	96 ... 1600	240 ... 1600	B	3VA2116-5KQ42-0AA0	1 910,—
3VA22	160	63 ... 160	96 ... 1600	240 ... 1920	B	3VA2216-5KQ42-0AA0	2 260,—
	250	100 ... 250	150 ... 2500	375 ... 2500	B	3VA2225-5KQ42-0AA0	2 260,—
3VA23	250	100 ... 250	150 ... 2500	375 ... 3000	B	3VA2325-5KQ42-0AA0	2 750,—
	400	160 ... 400	240 ... 4000	600 ... 4000	B	3VA2340-5KQ42-0AA0	2 920,—
3VA24	400	160 ... 400	240 ... 4000	600 ... 6000 ¹⁾	B	3VA2440-5KQ42-0AA0	3 380,—
	500	200 ... 500	300 ... 5000	750 ... 7000	B	3VA2450-5KQ42-0AA0	3 380,—
	630	250 ... 630	378 ... 5670	945 ... 5670	B	3VA2463-5KQ42-0AA0	3 600,—

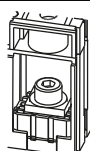

¹⁾ bei Schaltvermögen L 4400 A

Kompaktleistungsschalter 3VA2 bis 630 A, ETU, 400/690 V, bis 150 kA

Anlagenschutz

PE (ST, SZ, M) = 1

PKG*/VPE = 1 ST

PG = 12P

Bemes- sungs- strom I_n	LK	I_{cu} bis 85 kA bei 415 V, Hohes Schaltvermögen H H		LK	I_{cu} bis 110 kA bei 415 V, Sehr hohes Schaltvermögen C C		LK	I_{cu} bis 150 kA bei 415 V, Extrem hohes Schaltvermögen L L	
		siehe "Übersicht", S. 1/6 und 1/7			siehe "Übersicht", S. 1/6 und 1/7			siehe "Übersicht", S. 1/6 und 1/7	
		Artikel-Nr. www.siemens.com/ product?Artikel-Nr.	Grund- preis € pro PE		Artikel-Nr. www.siemens.com/ product?Artikel-Nr.	Grund- preis € pro PE		Artikel-Nr. www.siemens.com/ product?Artikel-Nr.	Grund- preis € pro PE
A									

Anlagen- und Generatorschutz, mit Anzeige, mit Messfunktion, ETU850 LSI

Mit einstellbarem Überlastauslöser I_r , einstellbarem verzögerten Kurzschlussauslöser I_{sd} und einstellbarem unverzögerten Kurzschlussauslöser I_i , mit "N"-Überlast- und Kurzschlussauslöser von 20 %/40 % bis 100 %/160 %

Anschluss Rahmenklemme

25	B	3VA2025-6KP46-0AA0	1 330,—	B	3VA2025-7KP46-0AA0	1 460,—	B	3VA2025-8KP46-0AA0	1 560,—
40	B	3VA2040-6KP46-0AA0	1 330,—	B	3VA2040-7KP46-0AA0	1 460,—	B	3VA2040-8KP46-0AA0	1 560,—
63	B	3VA2063-6KP46-0AA0	1 330,—	B	3VA2063-7KP46-0AA0	1 460,—	B	3VA2063-8KP46-0AA0	1 560,—
100	B	3VA2010-6KP46-0AA0	1 390,—	B	3VA2010-7KP46-0AA0	1 530,—	B	3VA2010-8KP46-0AA0	1 670,—
25	B	3VA2125-6KP46-0AA0	1 330,—	B	3VA2125-7KP46-0AA0	1 460,—	B	3VA2125-8KP46-0AA0	1 560,—
40	B	3VA2140-6KP46-0AA0	1 330,—	B	3VA2140-7KP46-0AA0	1 460,—	B	3VA2140-8KP46-0AA0	1 560,—
63	B	3VA2163-6KP46-0AA0	1 330,—	B	3VA2163-7KP46-0AA0	1 460,—	B	3VA2163-8KP46-0AA0	1 560,—
100	B	3VA2110-6KP46-0AA0	1 390,—	B	3VA2110-7KP46-0AA0	1 530,—	B	3VA2110-8KP46-0AA0	1 670,—
160	B	3VA2116-6KP46-0AA0	1 790,—	B	3VA2116-7KP46-0AA0	2 000,—	B	3VA2116-8KP46-0AA0	2 150,—

Anschluss Schraubenflanschanschluss

25	B	3VA2025-6KP42-0AA0	1 300,—	B	3VA2025-7KP42-0AA0	1 430,—	B	3VA2025-8KP42-0AA0	1 530,—
40	B	3VA2040-6KP42-0AA0	1 300,—	B	3VA2040-7KP42-0AA0	1 430,—	B	3VA2040-8KP42-0AA0	1 530,—
63	B	3VA2063-6KP42-0AA0	1 300,—	B	3VA2063-7KP42-0AA0	1 430,—	B	3VA2063-8KP42-0AA0	1 530,—
100	B	3VA2010-6KP42-0AA0	1 360,—	B	3VA2010-7KP42-0AA0	1 490,—	B	3VA2010-8KP42-0AA0	1 640,—
25	B	3VA2125-6KP42-0AA0	1 300,—	B	3VA2125-7KP42-0AA0	1 430,—	B	3VA2125-8KP42-0AA0	1 530,—
40	B	3VA2140-6KP42-0AA0	1 300,—	B	3VA2140-7KP42-0AA0	1 430,—	B	3VA2140-8KP42-0AA0	1 530,—
63	B	3VA2163-6KP42-0AA0	1 300,—	B	3VA2163-7KP42-0AA0	1 430,—	B	3VA2163-8KP42-0AA0	1 530,—
100	B	3VA2110-6KP42-0AA0	1 360,—	B	3VA2110-7KP42-0AA0	1 490,—	B	3VA2110-8KP42-0AA0	1 640,—
160	B	3VA2116-6KP42-0AA0	1 760,—	B	3VA2116-7KP42-0AA0	1 970,—	B	3VA2116-8KP42-0AA0	2 120,—
160	B	3VA2216-6KP42-0AA0	2 230,—	B	3VA2216-7KP42-0AA0	2 350,—	B	3VA2216-8KP42-0AA0	2 600,—
250	B	3VA2225-6KP42-0AA0	2 230,—	B	3VA2225-7KP42-0AA0	2 350,—	B	3VA2225-8KP42-0AA0	2 600,—
250	B	3VA2325-6KP42-0AA0	2 680,—	B	3VA2325-7KP42-0AA0	2 860,—	¹⁾ B	3VA2325-8KP42-0AA0	3 250,—
400	B	3VA2340-6KP42-0AA0	2 860,—	B	3VA2340-7KP42-0AA0	3 070,—	¹⁾ B	3VA2340-8KP42-0AA0	3 460,—
400	B	3VA2440-6KP42-0AA0	3 410,—	B	3VA2440-7KP42-0AA0	3 650,—	¹⁾ B	3VA2440-8KP42-0AA0	4 030,—
500	B	3VA2450-6KP42-0AA0	3 410,—	B	3VA2450-7KP42-0AA0	3 650,—		—	—
630	B	3VA2463-6KP42-0AA0	3 660,—	B	3VA2463-7KP42-0AA0	3 930,—	¹⁾ B	3VA2463-8KP42-0AA0	4 340,—

Anlagen- und Generatorschutz, mit Anzeige, mit Messfunktion, ETU860 LSI

Mit einstellbarem Überlastauslöser I_r , einstellbarem verzögerten Kurzschlussauslöser I_{sd} und einstellbarem unverzögerten Kurzschlussauslöser I_i , mit "N"-Überlast- und Kurzschlussauslöser von 20 %/40 % bis 100 %/160 % und einstellbarem Erdschlussauslöser I_G

Anschluss Rahmenklemme

25	B	3VA2025-6KQ46-0AA0	1 580,—	B	3VA2025-7KQ46-0AA0	1 720,—	B	3VA2025-8KQ46-0AA0	1 830,—
40	B	3VA2040-6KQ46-0AA0	1 580,—	B	3VA2040-7KQ46-0AA0	1 720,—	B	3VA2040-8KQ46-0AA0	1 830,—
63	B	3VA2063-6KQ46-0AA0	1 580,—	B	3VA2063-7KQ46-0AA0	1 720,—	B	3VA2063-8KQ46-0AA0	1 830,—
100	B	3VA2010-6KQ46-0AA0	1 650,—	B	3VA2010-7KQ46-0AA0	1 800,—	B	3VA2010-8KQ46-0AA0	1 920,—
25	B	3VA2125-6KQ46-0AA0	1 580,—	B	3VA2125-7KQ46-0AA0	1 720,—	B	3VA2125-8KQ46-0AA0	1 830,—
40	B	3VA2140-6KQ46-0AA0	1 580,—	B	3VA2140-7KQ46-0AA0	1 720,—	B	3VA2140-8KQ46-0AA0	1 830,—
63	B	3VA2163-6KQ46-0AA0	1 580,—	B	3VA2163-7KQ46-0AA0	1 720,—	B	3VA2163-8KQ46-0AA0	1 830,—
100	B	3VA2110-6KQ46-0AA0	1 650,—	B	3VA2110-7KQ46-0AA0	1 800,—	B	3VA2110-8KQ46-0AA0	1 920,—
160	B	3VA2116-6KQ46-0AA0	2 040,—	B	3VA2116-7KQ46-0AA0	2 240,—	B	3VA2116-8KQ46-0AA0	2 430,—

Anschluss Schraubenflanschanschluss

25	B	3VA2025-6KQ42-0AA0	1 520,—	B	3VA2025-7KQ42-0AA0	1 690,—	B	3VA2025-8KQ42-0AA0	1 800,—
40	B	3VA2040-6KQ42-0AA0	1 520,—	B	3VA2040-7KQ42-0AA0	1 690,—	B	3VA2040-8KQ42-0AA0	1 800,—
63	B	3VA2063-6KQ42-0AA0	1 520,—	B	3VA2063-7KQ42-0AA0	1 690,—	B	3VA2063-8KQ42-0AA0	1 800,—
100	B	3VA2010-6KQ42-0AA0	1 620,—	B	3VA2010-7KQ42-0AA0	1 770,—	B	3VA2010-8KQ42-0AA0	1 890,—
25	B	3VA2125-6KQ42-0AA0	1 520,—	B	3VA2125-7KQ42-0AA0	1 690,—	B	3VA2125-8KQ42-0AA0	1 800,—
40	B	3VA2140-6KQ42-0AA0	1 520,—	B	3VA2140-7KQ42-0AA0	1 690,—	B	3VA2140-8KQ42-0AA0	1 800,—
63	B	3VA2163-6KQ42-0AA0	1 520,—	B	3VA2163-7KQ42-0AA0	1 690,—	B	3VA2163-8KQ42-0AA0	1 800,—
100	B	3VA2110-6KQ42-0AA0	1 620,—	B	3VA2110-7KQ42-0AA0	1 770,—	B	3VA2110-8KQ42-0AA0	1 890,—
160	B	3VA2116-6KQ42-0AA0	2 000,—	B	3VA2116-7KQ42-0AA0	2 210,—	B	3VA2116-8KQ42-0AA0	2 400,—
160	B	3VA2216-6KQ42-0AA0	2 470,—	B	3VA2216-7KQ42-0AA0	2 630,—	B	3VA2216-8KQ42-0AA0	2 870,—
250	B	3VA2225-6KQ42-0AA0	2 470,—	B	3VA2225-7KQ42-0AA0	2 630,—	B	3VA2225-8KQ42-0AA0	2 870,—
250	B	3VA2325-6KQ42-0AA0	2 910,—	B	3VA2325-7KQ42-0AA0	3 080,—	¹⁾ B	3VA2325-8KQ42-0AA0	3 480,—
400	B	3VA2340-6KQ42-0AA0	3 120,—	B	3VA2340-7KQ42-0AA0	3 320,—	¹⁾ B	3VA2340-8KQ42-0AA0	3 710,—
400	B	3VA2440-6KQ42-0AA0	3 660,—	B	3VA2440-7KQ42-0AA0	3 890,—	¹⁾ B	3VA2440-8KQ42-0AA0	4 350,—
500	B	3VA2450-6KQ42-0AA0	3 660,—	B	3VA2450-7KQ42-0AA0	3 890,—		—	—
630	B	3VA2463-6KQ42-0AA0	3 910,—	B	3VA2463-7KQ42-0AA0	4 180,—	¹⁾ B	3VA2463-8KQ42-0AA0	4 600,—

¹⁾ Liefereinsatz voraussichtlich 3. Quartal 2015

* Diese Menge oder ein Vielfaches dieser Menge kann bestellt werden.
Unverbindliche Preisempfehlungen, ggf. zuzüglich Metallzuschläge (MZ)

Kompaktleistungsschalter 3VA2 bis 630 A, ETU, 400/690 V, bis 150 kA

Motor- und Starterschutz

PE (ST, SZ, M) = 1

PKG*/VPE = 1 ST

PG = 12P



Anschluss-technik	Typ	Bemessungsstrom I_n	Einstellstrom der stromabhängig verzögerten Überlastauslöser "L" I_r	S-Funktion (kurzzeitverzögerter Kurzschlusschutz "S") I_{sd}	Ansprechstrom der unverzögerten Kurzschlussauslöser "I" I_i	LK
		A	A	A	A	

I_{cu} bis 55 kA bei 415 V, Mittleres Schaltvermögen M (M)
siehe "Übersicht", S. 1/6 und 1/7

Artikel-Nr. www.siemens.com/product?Artikel-Nr. Grundpreis € pro PE

3-polig, Festeinbau, 3VA20 bis 3VA24, bis 630 A Elektronischer Überstromauslöser



I201_18428

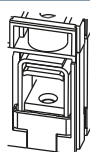

Starterschutz, ETU310M I

Mit einstellbarem Kurzschlussauslöser I_i

Anschluss Rahmenklemme

3VA21	25	40	63	100	--	--	75 ... 375	120 ... 600	189 ... 945	300 ... 1500

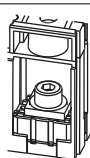
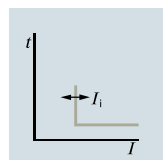

Anschluss Schraubenflächanschluss

3VA21	25	40	63	100	--	--	75 ... 375	120 ... 600	189 ... 945	300 ... 1500
3VA22	160	200	--	--	--	--	480 ... 2400	600 ... 3000	--	--
3VA23	250	--	--	--	--	--	750 ... 3750	--	--	--
3VA24	400	500	--	--	--	--	1200 ... 6000	1500 ... 7500	--	--



I201_18429

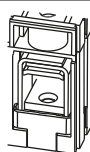

Motorschutz, ETU350M LSI

Mit einstellbarem Überlastauslöser I_r , einstellbarem verzögerten Kurzschlussauslöser I_{sd} und fest eingestelltem unverzögerten Kurzschlussauslöser I_i

$I_r \times \dots$

Anschluss Rahmenklemme

3VA21	25	40	63	100	10 ... 25	16 ... 40	25 ... 63	40 ... 100	3 ... 15	3 ... 15	3 ... 15	375	600	945	1500	B	B	B	B

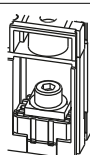
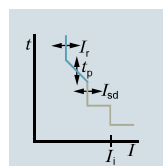

Anschluss Schraubanschluss

3VA21	25	40	63	100	10 ... 25	16 ... 40	25 ... 63	40 ... 100	3 ... 15	3 ... 15	3 ... 15	375	600	945	1500	B	B	B	B



I201_18484



Motorschutz, mit Anzeige, mit Messfunktion, ETU860M LSIG

Mit einstellbarem Überlastauslöser I_r , einstellbarem verzögerten Kurzschlussauslöser I_{sd} und einstellbarem unverzögerten Kurzschlussauslöser I_i und fest eingestelltem Erdschlussauslöser I_G

Anschluss Rahmenklemme

3VA21	25	40	63	100	10 ... 25	16 ... 40	25 ... 63	40 ... 100	38 ... 375	75 ... 375	75 ... 375	120 ... 600	189 ... 945	300 ... 1500	300 ... 1500	B	B	B	B

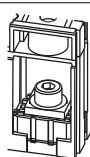
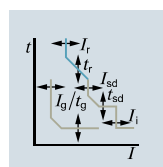

Anschluss Schraubanschluss

3VA21	25	40	63	100	10 ... 25	16 ... 40	25 ... 63	40 ... 100	30 ... 375	48 ... 600	76 ... 945	120 ... 1500	300 ... 1500	300 ... 1500	300 ... 1500	B	B	B	B

Kompaktleistungsschalter 3VA2 bis 630 A, ETU, 400/690 V, bis 150 kA

Motor- und Starterschutz

PE (ST, SZ, M) = 1

PKG*/VPE = 1 ST

PG = 12P

Bemes- sungs- strom I_n	LK	I_{cu} bis 85 kA bei 415 V, Hohes Schaltvermögen H siehe "Übersicht", S. 1/6 und 1/7	(H)	LK	I_{cu} bis 110 kA bei 415 V, Sehr hohes Schaltvermögen C siehe "Übersicht", S. 1/6 und 1/7	(C)	LK	I_{cu} bis 150 kA bei 415 V, Extrem hohes Schaltvermögen L siehe "Übersicht", S. 1/6 und 1/7	(L)
A		Artikel-Nr. www.siemens.com/ product?Artikel-Nr.	Grund- preis € pro PE		Artikel-Nr. www.siemens.com/ product?Artikel-Nr.	Grund- preis € pro PE		Artikel-Nr. www.siemens.com/ product?Artikel-Nr.	Grund- preis € pro PE

Starterschutz, ETU310M IMit einstellbarem Kurzschlussauslöser I_f

Anschluss Rahmenklemme		Anschluss Rahmenklemme		Anschluss Rahmenklemme			
25	--	B	3VA21 25-7MS36-0AA0	462,—	B	3VA21 25-8MS36-0AA0	532,—
40	--	B	3VA21 40-7MS36-0AA0	462,—	B	3VA21 40-8MS36-0AA0	532,—
63	--	B	3VA21 63-7MS36-0AA0	462,—	B	3VA21 63-8MS36-0AA0	532,—
100	--	B	3VA21 10-7MS36-0AA0	491,—	B	3VA21 10-8MS36-0AA0	566,—
Anschluss Schraubenflanschanschluss		Anschluss Schraubenflanschanschluss		Anschluss Schraubenflanschanschluss			
25	--	B	3VA21 25-7MS32-0AA0	438,—	B	3VA21 25-8MS32-0AA0	508,—
40	--	B	3VA21 40-7MS32-0AA0	438,—	B	3VA21 40-8MS32-0AA0	508,—
63	--	B	3VA21 63-7MS32-0AA0	438,—	B	3VA21 63-8MS32-0AA0	508,—
100	--	B	3VA21 10-7MS32-0AA0	467,—	B	3VA21 10-8MS32-0AA0	541,—
160	--	B	3VA22 16-7MS32-0AA0	880,—	B	3VA22 16-8MS32-0AA0	1 020,—
200	--	X	3VA22 20-7MS32-0AA0	1 060,—		--	
250	--	B	3VA23 25-7MS32-0AA0	1 440,—	B	3VA23 25-8MS32-0AA0	1 680,—
400	--	B	3VA24 40-7MS32-0AA0	1 820,—	B	3VA24 40-8MS32-0AA0	2 120,—
500	--	X	3VA24 50-7MS32-0AA0	2 200,—		--	

Motorschutz, ETU350M LSIMit einstellbarem Überlastauslöser I_p , einstellbarem verzögerten Kurzschlussauslöser I_{sd} und fest eingestelltem unverzögerten Kurzschlussauslöser I_f

Anschluss Rahmenklemme		Anschluss Rahmenklemme		Anschluss Rahmenklemme			
25	--	B	3VA21 25-7MN36-0AA0	644,—	B	3VA21 25-8MN36-0AA0	714,—
40	--	B	3VA21 40-7MN36-0AA0	644,—	B	3VA21 40-8MN36-0AA0	714,—
63	--	B	3VA21 63-7MN36-0AA0	644,—	B	3VA21 63-8MN36-0AA0	714,—
100	--	B	3VA21 10-7MN36-0AA0	673,—	B	3VA21 10-8MN36-0AA0	748,—
Anschluss Schraubenflanschanschluss		Anschluss Schraubenflanschanschluss		Anschluss Schraubenflanschanschluss			
25	--	B	3VA21 25-7MN32-0AA0	620,—	B	3VA21 25-8MN32-0AA0	690,—
40	--	B	3VA21 40-7MN32-0AA0	620,—	B	3VA21 40-8MN32-0AA0	690,—
63	--	B	3VA21 63-7MN32-0AA0	620,—	B	3VA21 63-8MN32-0AA0	690,—
100	--	B	3VA21 10-7MN32-0AA0	649,—	B	3VA21 10-8MN32-0AA0	723,—
160	--	B	3VA22 16-7MN32-0AA0	1 090,—	B	3VA22 16-8MN32-0AA0	1 230,—
200	--	X	3VA22 20-7MN32-0AA0	1 270,—		--	
250	--	B	3VA23 25-7MN32-0AA0	2 050,—	B	3VA23 25-8MN32-0AA0	2 280,—
400	--	B	3VA24 40-7MN32-0AA0	2 430,—	B	3VA24 40-8MN32-0AA0	2 720,—
500	--	X	3VA24 50-7MN32-0AA0	2 800,—		--	

Motorschutz, mit Anzeige, mit Messfunktion, ETU860M LSIgMit einstellbarem Überlastauslöser I_p , einstellbarem verzögerten Kurzschlussauslöser I_{sd} , und einstellbarem unverzögerten Kurzschlussauslöser I_f und fest eingestelltem Erdschlussauslöser I_g

Anschluss Rahmenklemme		Anschluss Rahmenklemme		Anschluss Rahmenklemme			
25	--	B	3VA21 25-7MQ36-0AA0	1 130,—	B	3VA21 25-8MQ36-0AA0	1 200,—
40	--	B	3VA21 40-7MQ36-0AA0	1 130,—	B	3VA21 40-8MQ36-0AA0	1 200,—
63	--	B	3VA21 63-7MQ36-0AA0	1 130,—	B	3VA21 63-8MQ36-0AA0	1 200,—
100	--	B	3VA21 10-7MQ36-0AA0	1 160,—	B	3VA21 10-8MQ36-0AA0	1 230,—
Anschluss Schraubenflanschanschluss		Anschluss Schraubenflanschanschluss		Anschluss Schraubenflanschanschluss			
25	--	B	3VA21 25-7MQ32-0AA0	1 100,—	B	3VA21 25-8MQ32-0AA0	1 170,—
40	--	B	3VA21 40-7MQ32-0AA0	1 100,—	B	3VA21 40-8MQ32-0AA0	1 170,—
63	--	B	3VA21 63-7MQ32-0AA0	1 100,—	B	3VA21 63-8MQ32-0AA0	1 170,—
100	--	B	3VA21 10-7MQ32-0AA0	1 130,—	B	3VA21 10-8MQ32-0AA0	1 210,—
160	--	B	3VA22 16-7MQ32-0AA0	1 550,—	B	3VA22 16-8MQ32-0AA0	1 690,—
200	--	X	3VA22 20-7MQ32-0AA0	1 730,—		--	
250	--	B	3VA23 25-7MQ32-0AA0	2 290,—	B	3VA23 25-8MQ32-0AA0	2 520,—
400	--	B	3VA24 40-7MQ32-0AA0	2 670,—	B	3VA24 40-8MQ32-0AA0	2 960,—
500	--	X	3VA24 50-7MQ32-0AA0	3 040,—		--	

Kompaktleistungsschalter 3VA2 bis 630 A, ETU, 400/690 V, bis 150 kA

Maßzeichnungen

Übersicht

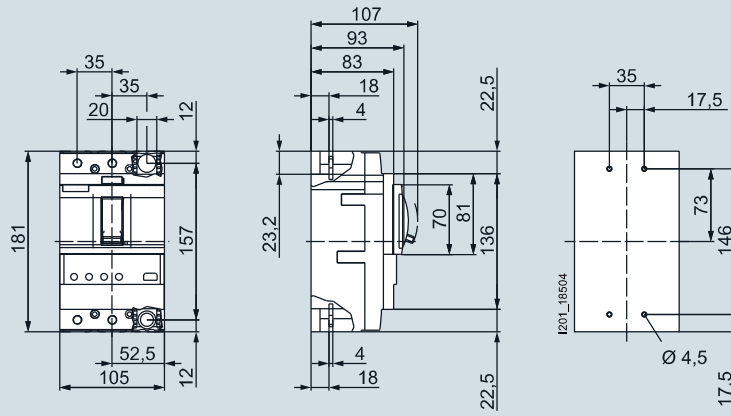

3VA20, 3VA21 und 3VA22, 3-polig

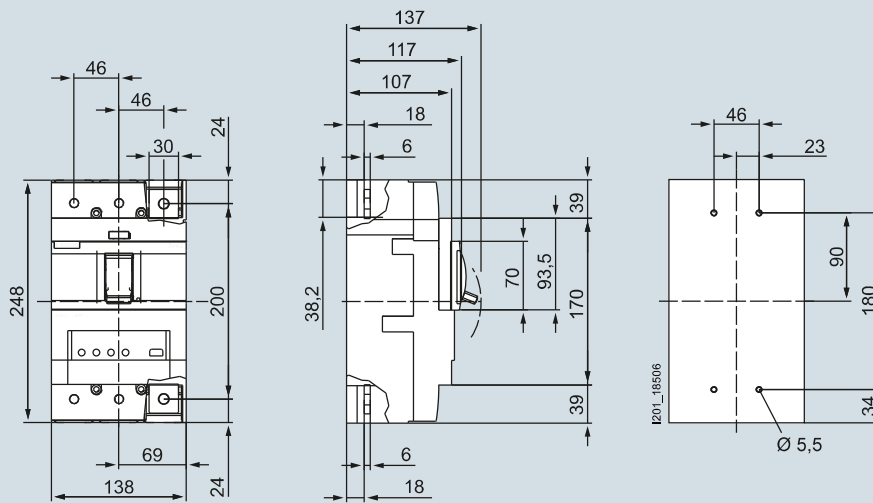

3VA23 und 3VA24, 3-polig